



SCE1500TB-EV

Telescopic Boom Crawler Crane

Quality Changes the World



Max. Lifting Capacity: 150t
Max. Boom Length: 59.9m
Max. Boom + Jib Length: 59.9m+15.5m

The parameters, pictures and standard/optional equipment are only for reference in this brochure, the actual machine is based on the effective price list and contract.



Telescopic Boom Crawler Crane SCE1500TB-EV

P03

Main Features

- Product Specification
- Safety Device

P08

Technical Parameters

- Main Performance Parameters
- Dimensions
- Transport Dimension
- Transport Plan
- Self-Assembly Procedure

P18

Boom and Jib Combinations

- (H) Main Boom Operating Conditions
- (HC) Auxiliary Lifting Sheave Operating Conditions
- (FJ) Fixed Jib Operating Conditions
- (FJh) Heavy Duty Jib Operating Conditions



**SCE1500TB-EV
TELESCOPIC BOOM CRAWLER CRANE
150 TONS LIFTING CAPACITY**

Main Features

- Page 04 Product Specification
- Page 06 Safety Devices

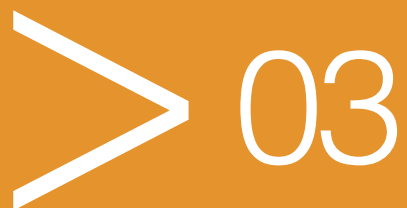

Product Specification



Power Battery

- Cell type: LFP (lithium iron phosphate).
- Battery pack operating voltage: 472.5-689.85V.
- Rated energy storage: 367.58kWh.
- Max. continuous charging current: Single electric gun: 200A, Dual electric gun: 400A.
- Battery case protection level: IP68.
- Way of battery heat dissipation: Liquid cooling.

Drive Motor

- Model: Danfoss EM-PMI375-T1100-1500.
- Type: Permanent magnet synchronous machine.
- Rated voltage: 600VDC.
- Rated power: 206kW, @65°C.
- Rated speed: 1500r/min.
- Rated torque: 1310N·m.
- Cooling system: Water cooling.

Charge Function

- Quick charge: Single charging gun: 200A (continuous), Dual charging gun: 400A (continuous) supported.
- Slow charge: Max.63A (continuous), 125A (optional), charging while working supported.

High Voltage Safety Design

- Electric leakage protection: High voltage of whole machine has real-time insulation monitoring function, able to cut off high voltage circuit initiatively when sudden electric leakage happens and alarms, protecting high voltage safety.
- Alarm of battery overheating out of control: When the power battery is overheated and out of control, the battery system can not catch fire or explode at least 5 minutes, and at the same time, alarm signals are sent tout on the display screen to reserve time for the driver to escape.
- Shielding and shell electric shock protection: The shell connector of high voltage components meet IPXXB (Finger touch prevention).
- High voltage interlock: Real-time monitor the interlocking status of high-voltage connectors on high -voltage components, give an alarm and forbid high-voltage power-on when interlocking is abnormal.
- Waterproof and dustproof: The waterproof and dustproof grade of all high-voltage components shall not be lower than IP67.

Electrical Control System

- Self-developed SYIC-III integrated control system is adopted with higher integration, precise operation and reliable quality.
- Control system consists of power battery system, drive motor system, power supply system and main control system, torque limiter system, auxiliary system and safety monitoring system. The controller, CAN BUS technology is applied between display, power battery system and drive motor system Line data communication.
- Monitor: The working parameters and status are shown on the monitor, such as power battery SOC, power battery voltage, power battery charge and discharge Current, instantaneous power of driving motor, charging mark, lifting weight and boom Angle and other working parameters Number and working status.

Hydraulic System

- Main pump: Adopt open piston pump with large variable displacement.
- Swing pump: Variable close piston pump for swing.
- Control: The main piston pump of variable displacement, winch piston motor of limitless variable displacement, control system of hydraulic positive flow.
- Way of cooling: Heat exchanger, fan core and multi-stage cooling.
- Filter: Large flow, high accuracy filter, with bypass valve and indicator, which can remind the user to replace the filter element in time.
- Max. pressure of system:
Main load, aux. load, and travel system: 32MPa.
Boom hoist cylinder lifting: 32MPa.
Swing system: 24MPa.
Control system: 4.5MPa.
Hydraulic tank capacity: 1000L.

Main and Aux. Hoist Winch

- Pump and motor: Dual-placement speed controlled energyefficient, combination of winch balance valve and anti-hook sliding technology, lifting or lowering the load steadily.
- Winch brake adopts concealed, normally closed, wet type and spring loaded fin type normally engaged brake, spring force braking, oil pressure released.
- Branded rotation resistant high-strength steel wire ropes.
- Main and aux. load hoist winches adopt piston motor of fixed displacement to drive planetary reducer.

Main hoisting winch	Rope speed on the outermost work layer	0~136m/min
	Wire rope diameter	Φ22mm
	Wire rope length of main hoist	280m
	Rated single line pull	9.5t
Auxiliary hoisting winch	Rope speed on the outermost work layer	0~136m/min
	Wire rope diameter	Φ22mm
	Wire rope length of auxiliary hoist	190m
	Rated single line pull	9.5t



Product Specification

Boom Hoist

- Double acting single piston rod hydraulic cylinder, fitted with safety balance valve, luffing angle: $-2.1^{\circ}\sim 81.5^{\circ}$, adopting passive luffing down system to reduce the energy consumption and improve the steadiness of luffing operation.

Swing Mechanism

- Swing brake adopts concealed, normally closed, wet type and spring loaded fin type normally engaged brake, spring force braking oil pressure released.
- With integrated cushion valve, the swing system has free slip function to realize steady swing start and control, showing outstanding microinching performance.
- Unique swing cushion design ensures more stable braking.
- Swing drive: External gearing swing drive, capable of conducting 360° rotation, maximum rotation speed 1.5r/min. The maximum driving pressure can reach 24MPa.
- Branded motor reducer, more reliable.
- Swing lockout: Locking device, to ensure that the superstructure can be locked in front and rear directions conveniently and reliably during off-work time and transportation.
- Swing bearing: Single row ball bearing.

Counterweight

- Self-assembled counterweight: Tray 10t \times 1, rear counterweight A 8t \times 2, and rear counterweight B 2.5t \times 4.
- Carbody counterweight: 5t \times 2 at the front and rear of carbody.

Upperworks

- High-strength steel weld framework. Design allows for easy maintenance and service.

Cab and Control

- New operator's cab with fashionable profile, nice interior and large window glass. There are low and high-beam lights, left side rear view swing mirror, heater and A/C, radio and other functions. The layout of seat, handles, control buttons are designed with ergonomic principles to make operation more comfortable.
- Cab layout: Dual 10.1-inch touch screen, programmable smart switches, and improved touch screen interference.
- Armrest box: On the left and right armrest box are control handles, electrical switches, emergent stop and ignition switch. The armrest box can be adjusted along with the seat.
- Seat: Multi-way and multi-level floating adjustable seat with unload switch.
- A/C: Cool and heat air; optimized air channels and vents.
- Multiple cameras can be displayed on the monitor at the same time to realize backing video, real-time monitoring of wire rope on each winch, conditions behind the counterweight and surrounding the machine.

Traveling Drive

- Independent traveling drive device is adopted for each side of crawler frame, so as to realize straight travel, turning through reducer and drive wheel by travel motor.
- Traveling speed: The traveling can be switched between high speed and low speed, and the high speed can be up to 2km/h.
- Gradeability: 30%.

Traveling Braking

- Concealed wet type and spring loaded fin type normally engaged brake, spring force braking, oil pressure released.

Side Frame Extension and Retraction

- Pressure of 25MPa by aux. system pushes the cylinder to realize the extension and retracting of the side frames. The side frames are extended at work and retracted for transport with the whole basic machine.

Crawler Tensioning

- Use the jack to push the guide wheel and insert the shim to adjust crawler tension.

Steering System

- It can realize single track turning and pivot turning.

Track Shoe

- High-strength alloy cast steel track pad can prolong the service life. Width 950mm.

Track Roller

- Maintenance-free track roller.

Outrigger

- Outrigger cylinder is offered to facilitate the side frame disassembly during jobsite transfer.

Product Specification



Boom

- The boom is made of high-strength steel structure with U-shape profile, with six sections, of which the basic boom is 12.92m and the max. boom length is 59.9m.
- Full power with single cylinder and plug for telescoping.

Fixed Jib

- Bi-fold fixed jib length of 9.4m and 15.5m.
- Offset angle includes 0°, 15° and 30°.

Heavy Duty Jib

- Heavy duty jib length of 3m.
- Offset angle includes 30°, 45°.

Boom Tip Pulley

- Welding structure, connected with the boom through pin, and used for auxiliary hook operation.

Hook Block

Name	Capacity	No. of Sheaves	Weight	Notes
1	130t	7	1.40t	Optional
2	100t	5	1.24t	Optional
3	80t	3	0.69t	Optional
4	30t	1	0.42t	Optional
5	12.5t	0	0.25t	Optional

Main (Front) and Auxiliary (Rear) Winches - 22mm Rope

	Maximum Line Pull	Normal Line Speed	High Line Speed	Layer	Total
Layer	kg	m/min	m/min	m	m
1	11502	73.5	112.3	63.8	63.8
2	10720.9	78.8	120.5	68.4	132.2
3	10039.2	84.2	128.7	73.1	205.3
4	9439	89.5	136.9	77.7	283.0

Wire Rope Application	Diameter	Type	Maximum Permissible Load
	mm		kg
Main (Front) Winch	22	35W×K7 rotation resistant-right lang lay (Type ZZ)	9480
Auxiliary (Rear) Winch	22	35W×K7 rotation resistant-right lang lay (Type ZZ)	9480

Safety Device



Load Moment Indicator (LMI)

- The integrated LMI system is provided as standard and high safety and efficiency for equipment control.
- Based on lifting mechanics modes, the LMI computing system enables the loading precision, by empty-load calibration, to 0-10% and protects loading operation all-around; The system alarms once over-loaded to ensure safety.
- LMI can automatically detect the load weight, work radius and boom angle, and present on the display the rated load, actual load, work radius and boom angle. In normal operation, the LMI can make a judgment and cut off automatically if the crane moves towards dangerous direction. It can also perform as a black box to record the lifting information.
- Composition: Monitor, controller, length and angle sensor, pressure sensor, etc.

Assembly / Work Mode Control Switch

- In assembly mode, some safety devices are disabled for crane assembly.
- In work mode, all safety devices activate to protect the operation.

Emergency Stop

- When this button is pressed down, power supply of whole machine is cut off and all actions stop.

Over-hoist Protection of the Main / Auxiliary Hooks

- A2B limit switch is equipped on the boom/jib tip, which prevents the hook lifting up too much. When the hook is lifted up to the limit height, the limit switch activates, alarm pops up on the monitor, buzzer on the right front control panel sends alarm, failure indicator light starts to flash and the hook hoisting action is cut off automatically.

Over-release Protection Device of the Main / Auxiliary Winch

- The 3rd-wrap indicator is installed on main and aux. load hoist to prevent over-release of wire rope. When the rope is paid out close to the last three wraps, the limit switch acts, and the system sends alarm through buzzer and show the alarm on the monitor, automatically cutting off the winch action.

Safety Device



Function Lock

- If the function lock level is not in work position, all the other handles won't work, which prevents any mis-operation caused by accidental collision.

Swing Lock

- The electrical locking function is available. In case of unintentional joystick movement, the swing motion is not valid until pressing the lock release key on the touchscreen.

Hook Latch

- The lifting hook is installed with a baffle plate to prevent wire rope from falling off.

Tri-color Load Indicator

- The load indicator light has three colors, i.e., green, yellow and red; and the real time load status is presented on the display. When the actual load is smaller than 90% of rated load, the green light is on; when the actual load is larger than 90% and smaller than 100%, the yellow light is on, the alarm light flashes and sends out continuous sirens; when the actual load reaches 100% of rated load, the red light is on, the alarm light flashes and sends out continuous sirens. At this moment, the system will automatically cut off the crane's dangerous operation.

Flash Alarm

- When the LMI is powered on, the flash alarm will turn on.

Swing Indicator Light

- The swing indicator light flashes during traveling or swing.

Seat Interlock Protection

- If the operator leaves the seat, all control handles and switches will be disabled immediately to prevent any mis-operation due to accidental collision.

Illuminating Light

- The machine is equipped with short-beam light in front of machine, lamps in operator's cab and lighting devices for night operation, as well as boom lights, so as to increase the visibility during work.

Rear View Mirror

- It is installed at the front of the operator's cab, at the right handrail of the platform and near the winches.

Level Indicator

- Electrical level indicator can show the inclination angle of superstructure on the monitor.

Closed Circuit Monitoring System

- There are two cameras and illuminating lights on the tail of rotating bed, which can show the rear part and winches working on the machine.

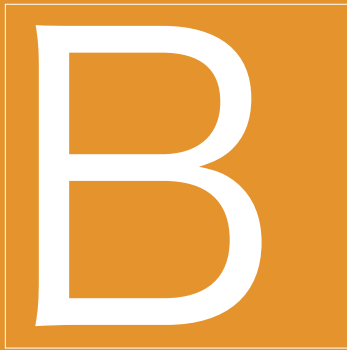

SCE1500TB-EV
TELESCOPIC BOOM CRAWLER CRANE
150 TONS LIFTING CAPACITY

Technical Parameters

- Page 09 Main Performance Parameters
- Page 10 Dimensions
- Page 11 Transport Dimension
- Page 14 Transport Plan
- Page 17 Self-assembly Procedure



Main Performance Parameters

Main Performance Parameters of SCE1500TB-EV			
Performance Indicators		Unit	Parameter
Outline Dimension	Length	mm	16602
	Width	mm	5851 (Extended) 4921 (Intermediate) 3991 (Retracted)
	Height	mm	4814
	Distance between the center of drive sprocket and idler	mm	6185
	Width of track shoe	mm	950
H	Max. rated lifting capacity	t	150
	Boom length	m	12.92~59.9
	Boom angle	°	-2.1~81.5
	Max. rated lifting moment	t·m	480
FJ	Longest main boom + longest jib	m	59.9+15.5
	Jib angle	°	0, 15, 30
FJh	Longest main boom + longest jib	m	59.9+3
	Jib angle	°	30, 45
Speed	Rope speed of main/aux. winch (the outermost work layer)	m/min	0~136
	Time to fully luffing up/down	s	90/90
	Slewing speed	rpm	0~1.5
	Travel speed	km/h	0~2
Wire Rope	Diameter	mm	Φ22
Drive Motor	Model	/	EM-PMI375-T1100-1500
	Rated power/speed	rpm	1500
Transport	Operating weight	t	130.7
	Basic machine weight	t	48.57
	Transportation dimension (L×W×H)	mm	16045×3390×3323
Other Parameters	Average ground pressure	Mpa	0.12
	Min. swing radius	mm	5092

Dimensions

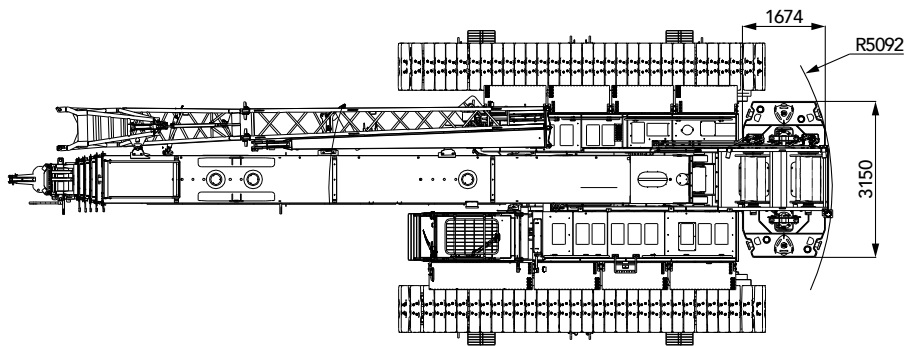
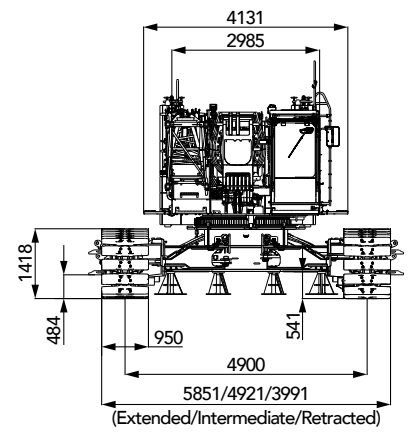
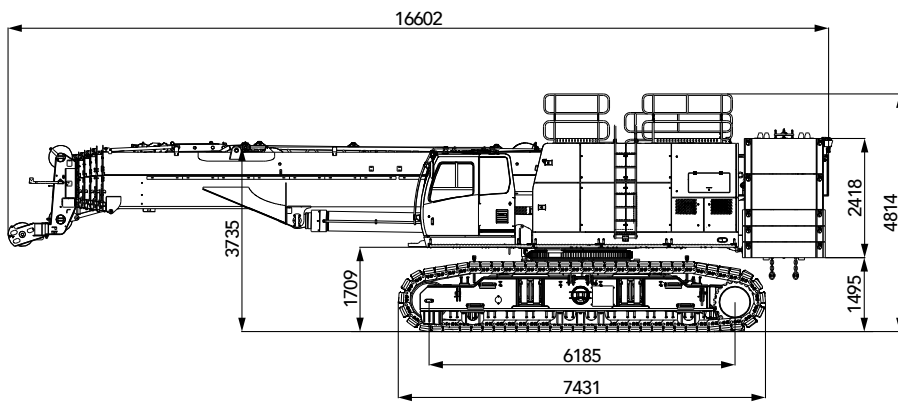

Transport Dimension

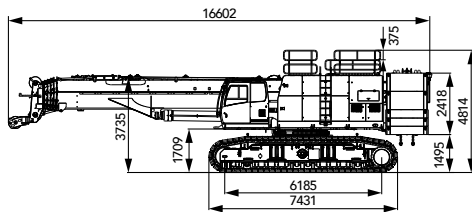

Basic Machine (with side frame, main & aux. winches and wire ropes, fixed jib and aux. lifting sheave and full counterweights) ×1

Length (L)	16.60m
Width (W)	5.86m
Height (H)	4.45m
Weight	130.7t

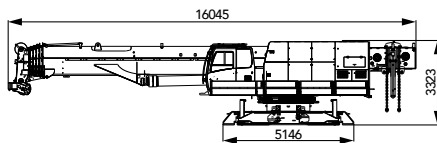

Basic Machine (with main & aux. winches, wire rope and aux. lifting sheave, without fixed jib) ×1

Length (L)	16.05m
Width (W)	3.39m
Height (H)	3.33m
Weight	48.57t

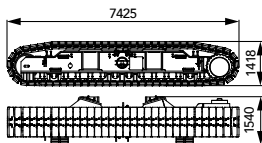

Left Side Frame ×1

Length (L)	7.43m
Width (W)	1.54m
Height (H)	1.42m
Weight	17.1t

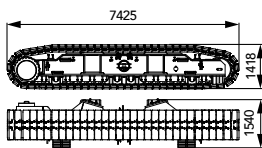

Right Side Frame ×1

Length (L)	7.43m
Width (W)	1.54m
Height (H)	1.42m
Weight	17.1t

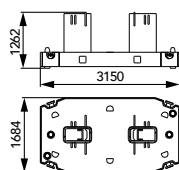

Counterweight Tray ×1

Length (L)	3.15m
Width (W)	1.68m
Height (H)	1.26m
Weight	10.0t

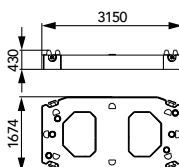

Rear Counterweight A ×2

Length (L)	3.15m
Width (W)	1.67m
Height (H)	0.43m
Weight	8.0t

Transport Dimension

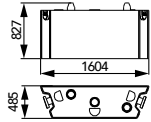

Rear Counterweight B ×4

Length (L)	1.60m
Width (W)	0.49m
Height (H)	0.83m
Weight	2.5t

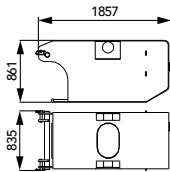

Carbody Counterweight ×2

Length (L)	1.86m
Width (W)	0.84m
Height (H)	0.86m
Weight	5.0t

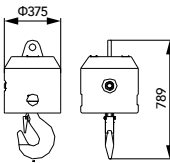

12.5t Hook Ball ×1

Length (L)	0.38m
Width (W)	0.38m
Height (H)	0.79m
Weight	0.25t

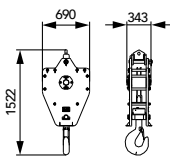

30t Hook Block ×1

Length (L)	0.69m
Width (W)	0.34m
Height (H)	1.52m
Weight	0.42t

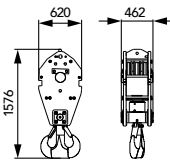

80t Hook Block ×1

Length (L)	0.62m
Width (W)	0.46m
Height (H)	1.58m
Weight	0.69t

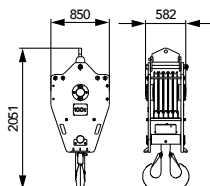

100t Hook Block ×1

Length (L)	0.85m
Width (W)	0.58m
Height (H)	2.05m
Weight	1.24t

Transport Dimension

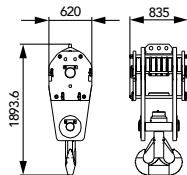

130t Hook Block ×1

Length (L)	0.62m
Width (W)	0.84m
Height (H)	1.89m
Weight	1.4t

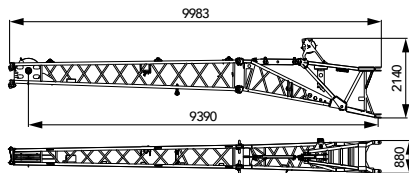

9.4m Fixed Jib Base ×1

Length (L)	9.98m
Width (W)	0.88m
Height (H)	2.14m
Weight	1.08t

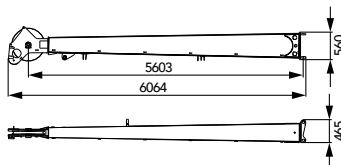

6m Fixed Jib Tip ×1

Length (L)	6.06m
Width (W)	0.47m
Height (H)	0.56m
Weight	0.42t

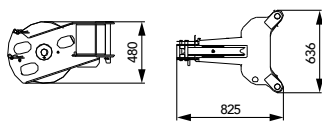

Aux. Lifting Sheave ×1

Length (L)	0.83m
Width (W)	0.62m
Height (H)	0.48m
Weight	0.11t

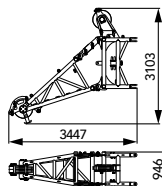

3m Heavy Duty Jib ×1

Length (L)	3.45m
Width (W)	0.95m
Height (H)	3.10m
Weight	0.98t

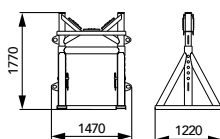

Boom Support Bracket ×1

Length (L)	1.47m
Width (W)	1.22m
Height (H)	1.77m
Weight	0.40t

Transport Plan

■ Transport Dimensions:

Basic Machine (with main & aux. winches, wire rope and aux. lifting sheave, without fixed jib): 48970kg

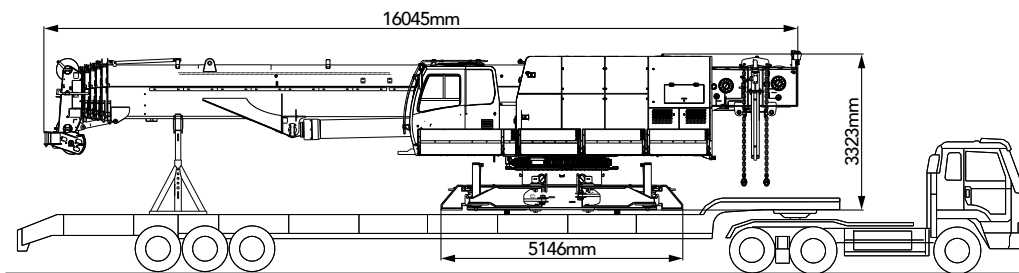

Item	Weight kg	Dimension m (L×W×H)	Trailer				
			1	2	3	4	5
Basic Machine (with 2 winches, boom, wire rope, aux. nose sheave)	48970	16.05×3.1×3.33	×				
Left Side Frame	17100	7.43×1.54×1.42		×			
Right Side Frame	17100	7.43×1.54×1.42			×		
Counterweight Tray	10000	3.15×1.68×1.26					×
Rear Counterweight A - 1 Piece	8000	3.15×1.67×0.43				×	
Rear Counterweight A - 1 Piece	8000	3.15×1.67×0.43				×	
Rear Counterweight B - 1 Piece	2500	1.60×0.49×0.69					×
Rear Counterweight B - 1 Piece	2500	1.60×0.49×0.69					×
Rear Counterweight B - 1 Piece	2500	1.60×0.49×0.69					×
Rear Counterweight B - 1 Piece	2500	1.60×0.49×0.69					×
Carbody Counterweight - 1 Piece	5000	1.86×0.84×0.86		×			
Carbody Counterweight - 1 Piece	5000	1.86×0.84×0.86			×		
Bi-fold Fixed Jib	1500	9.98×0.88×2.14				×	
Heavy Duty Jib	980	3.45×0.95×3.10					×
Hook Block - 12.5t	250	0.38×0.38×0.79				×	
Hook Block - 30t	420	0.69×0.34×1.52				×	
Hook Block - 80t	690	0.62×0.46×1.58				×	
Hook Block - 100t	1240	0.85×0.58×2.05				×	
Hook Block - 130t	1400	0.62×0.84×1.89				×	
Total Net Weight On Trailer			48970	22100	22100	21500	20980

Notes:

1.The transport dimensions of each part in the table are schematic, not proportional to the real parts.

The dimensions are designed value without package considered.

2.The Weight is designed value that the actual manufactured part may deviate a little.

Transport Plan

Left Side Frame + Carbody Counterweight: 22100kg

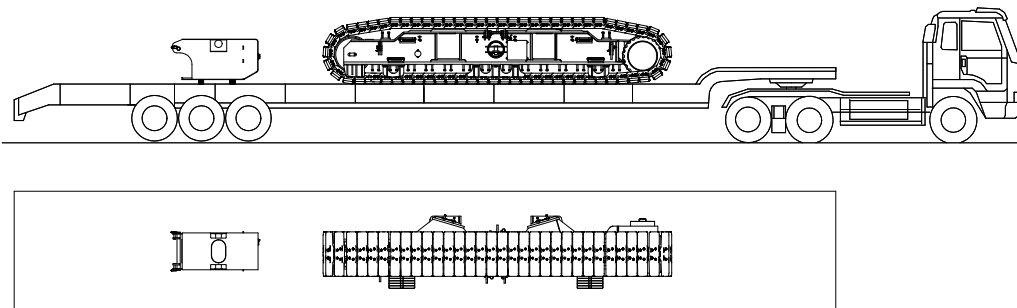

Right Side Frame + Carbody Counterweight: 22100kg

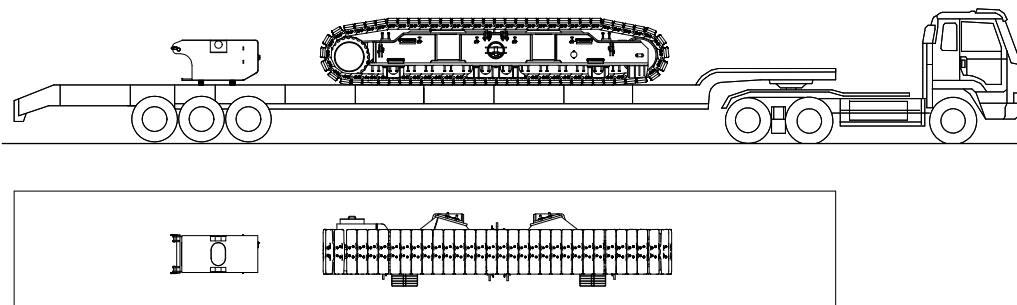

Transport Plan

Rear Counterweight A×2 + All Hooks + Bi-fold Fixed Jib: 21500kg

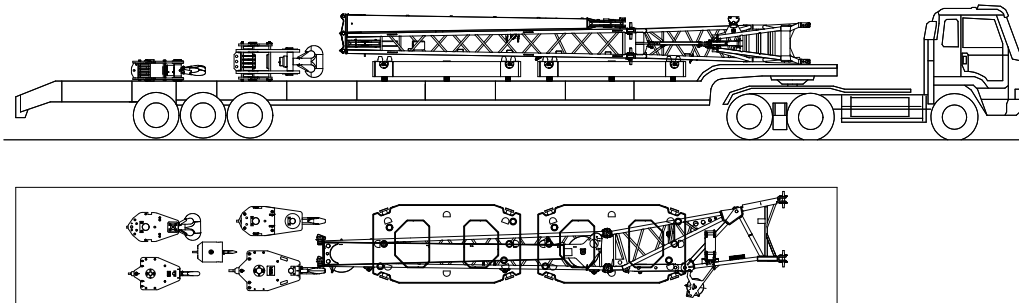

Counterweight Tray + Rear Counterweight B×4 + Heavy Duty Jib: 20980kg

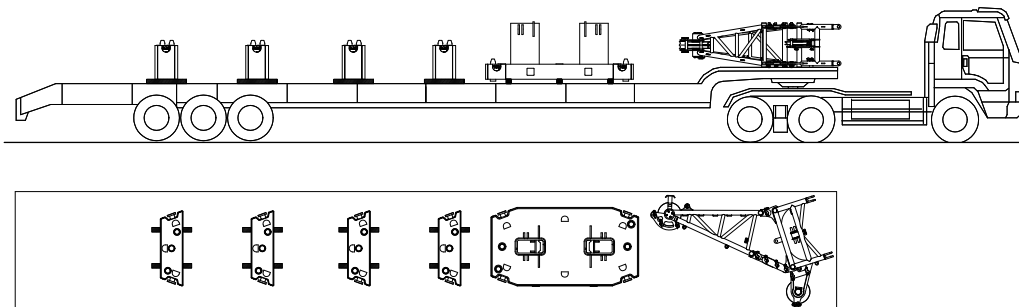

Self-Assembly Procedure

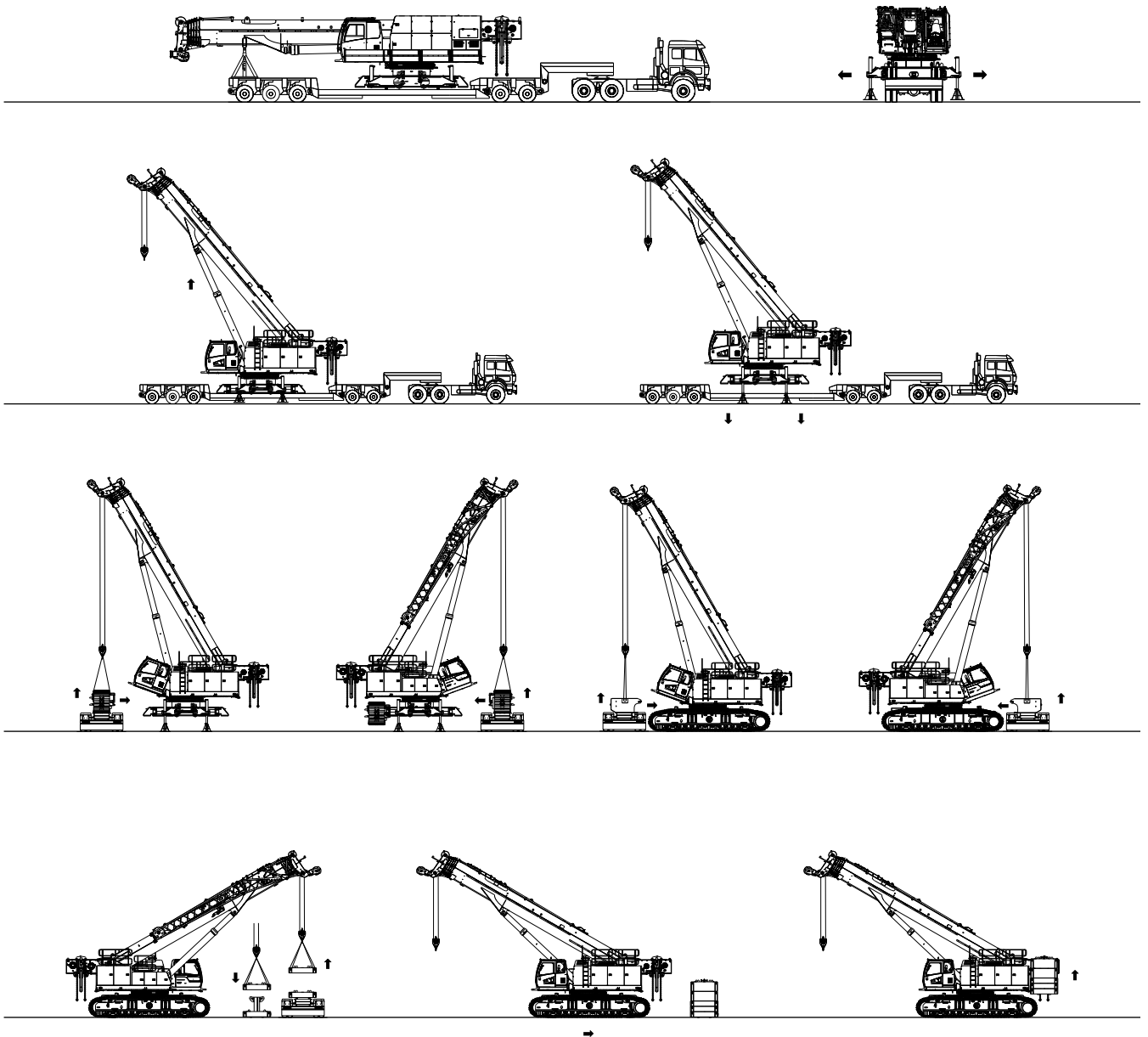



**SCE1500TB-EV
TELESCOPIC BOOM CRAWLER CRANE
150 TONS LIFTING CAPACITY**

Boom and Jib Combinations

- Page 20 (H) Main Boom Operating Conditions
- Page 28 (HC) Auxiliary Lifting Sheave Operating Conditions
- Page 30 (FJ) Fixed Jib Operating Conditions
- Page 33 (FJh) Heavy Duty Jib Operating Conditions

> 18

Boom and Jib Combinations



H Configuration
(12.92m~59.9m)

HC Configuration
(13.69m~60.68m)

FJ Configuration
(59.9m+15.5m)

FJh Configuration
(59.9m+3m)

(H) Main Boom Range Diagram

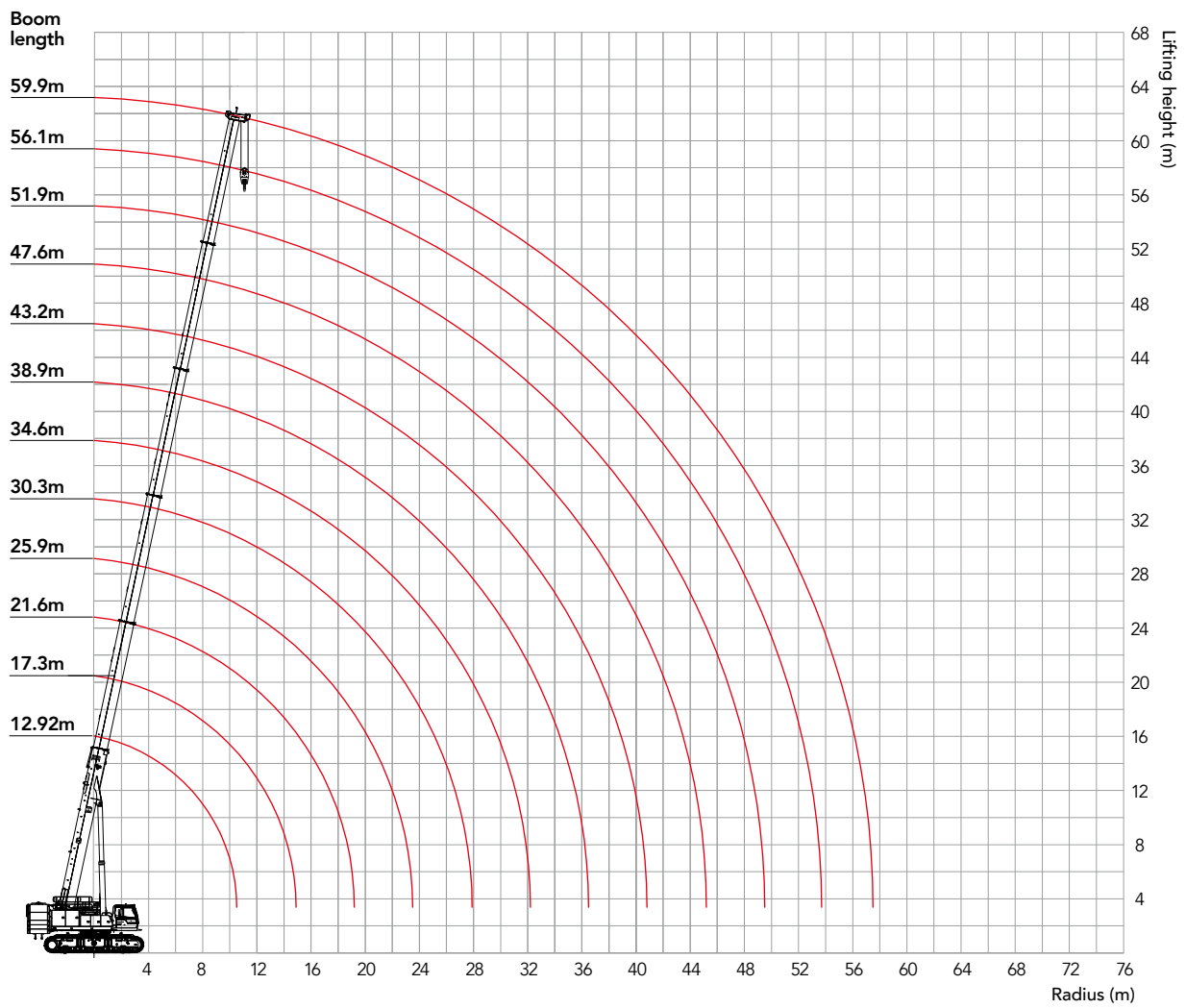

(H) Main Boom Load Chart

Unit: t

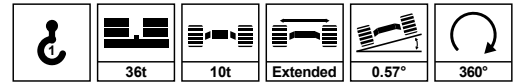





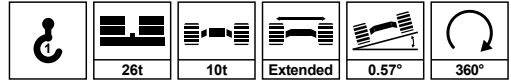

m	Main Boom Length (m)												m
	12.92	17.26	21.61	25.94	30.26	34.54	38.87	43.22	47.55	51.88	56.14	59.9	
2.8	150.0												2.8
3	130.0	94.8											3
3.5	116.5	94.8	89.9										3.5
4	111.6	94.8	89.9										4
4.5	106.7	94.8	89.9	80.2									4.5
5	94.8	94.8	89.9	80.2	55.0								5
5.5	87.2	87.2	87.2	79.4	55.0								5.5
6	80.0	80.0	80.0	76.7	55.0	44.0							6
7	68.5	68.5	68.5	66.0	55.0	41.8	35.7						7
8	60.0	60.0	57.9	56.0	52.2	40.1	33.1	29.3					8
9	50.9	52.0	49.7	48.4	47.3	38.3	30.9	28.0	22.8				9
10	42.7	43.8	43.3	42.4	41.7	36.7	28.8	26.2	22.8	17.5			10
11		37.5	37.4	37.5	37.1	35.2	27.0	24.6	21.6	17.5	14.1		11
12		32.6	32.5	33.5	33.3	33.2	25.4	23.2	20.5	17.5	14.1	12.2	12
13		28.6	28.5	29.5	30.1	30.1	23.9	21.9	19.5	16.9	14.1	12.2	13
14		25.3	25.2	26.1	27.1	27.5	22.5	20.7	18.6	16.1	13.9	11.6	14
16			20.1	21.0	21.9	22.8	20.2	18.5	16.9	14.7	12.9	9.9	16
18			16.3	17.2	18.1	19.0	18.2	16.7	15.3	13.5	12.1	8.6	18
20				14.2	15.1	16.0	15.7	15.2	13.9	12.5	11.3	7.6	20
22				11.9	12.8	13.7	13.3	13.3	12.8	11.6	10.6	6.7	22
24					10.9	11.7	11.4	11.4	11.6	10.6	9.9	5.9	24
26					9.3	10.1	9.8	9.8	10.0	9.6	9.1	5.3	26
28						8.8	8.5	8.5	8.7	8.8	8.3	4.7	28
30						7.6	7.3	7.3	7.6	7.9	7.6	4.2	30
32						6.6	6.3	6.3	6.6	6.9	7.0	3.8	32
34							5.5	5.5	5.7	6.0	6.4	3.4	34
36							4.7	4.7	4.9	5.3	5.7	3.1	36
38								4.0	4.3	4.6	5.0	2.8	38
40								3.4	3.7	4.0	4.4	2.5	40
42									3.1	3.5	3.9	2.2	42
44									2.6	3.0	3.4	2.0	44
46										2.5	2.9	1.8	46
48										2.1	2.5	1.6	48
50											2.1	1.4	50
52											1.8	1.3	52
54												1.1	54
56												1.0	56
	16	10	10	9	6	5	4	3	3	2	2	2	
	2#	0	0	46	46	46	46	92	92	92	92	100	2#
	3#	0	46	46	46	46	46	46	92	92	92	100	3#
	4#	0	0	0	46	46	46	46	46	92	92	100	4#
	5#	0	0	0	0	46	46	46	46	46	92	100	5#
	6#	0	0	0	0	0	46	46	46	46	46	92	6#
	0	0	0	0	0	0	0	0	0	10	10	10	

(H) Main Boom Load Chart

Unit: t



 m	Main Boom Length (m)												 m	
	12.92	17.26	21.61	25.94	30.26	34.54	38.87	43.22	47.55	51.88	56.14	59.9		
3	94.8	94.8												3
3.5	94.8	94.8	89.9											3.5
4	94.8	94.8	89.9											4
4.5	94.8	94.8	89.9	80.2										4.5
5	94.8	89.7	80.4	74.4	55.0									5
5.5	87.2	79.4	71.7	66.8	55.0									5.5
6	77.7	71.0	64.5	60.6	55.0	44.0								6
7	60.3	58.2	53.4	50.7	48.6	41.8	35.7							7
8	48.0	48.4	45.2	43.4	41.9	40.1	33.1	29.3						8
9	39.3	39.9	38.9	37.6	36.6	35.9	30.9	28.0	22.8					9
10	32.9	33.6	33.2	33.0	32.4	31.9	28.8	26.2	22.8	17.5				10
11		28.7	28.4	29.1	28.8	28.6	26.9	24.6	21.6	17.5	14.1			11
12		24.9	24.6	25.3	25.9	25.8	24.3	23.2	20.5	17.5	14.1	12.2		12
13		21.8	21.5	22.2	23.0	23.4	22.0	21.2	19.5	16.9	14.1	12.2		13
14		19.2	18.9	19.6	20.4	21.2	20.1	19.4	18.6	16.1	13.9	11.6		14
16			14.9	15.6	16.4	17.2	16.7	16.3	16.0	14.7	12.9	9.9		16
18			11.9	12.7	13.4	14.2	13.8	13.7	13.6	13.5	12.1	8.6		18
20				10.3	11.1	11.9	11.5	11.4	11.6	11.8	11.3	7.6		20
22				8.5	9.3	10.0	9.6	9.6	9.8	10.1	10.4	6.7		22
24					7.8	8.5	8.1	8.1	8.3	8.6	8.9	5.9		24
26					6.5	7.3	6.9	6.9	7.1	7.4	7.7	5.3		26
28						6.2	5.8	5.8	6.0	6.3	6.7	4.7		28
30						5.3	4.9	4.9	5.1	5.4	5.8	4.2		30
32						4.5	4.2	4.1	4.3	4.6	5.0	3.8		32
34							3.5	3.5	3.6	3.9	4.3	3.4		34
36							2.9	2.9	3.0	3.3	3.7	3.1		36
38								2.3	2.5	2.8	3.2	2.8		38
40								1.9	2	2.3	2.7	2.5		40
42									1.6	1.9	2.3	2.2		42
44									1.2	1.5	1.9	1.9		44
46										1.2	1.5	1.6		46
48											1.2	1.2		48
	10	10	10	9	6	5	4	4	3	2	2	2		
	2#	0	0	46	46	46	46	92	92	92	92	92	100	2#
	3#	0	46	46	46	46	46	46	92	92	92	92	100	3#
	4#	0	0	0	46	46	46	46	46	92	92	92	100	4#
	5#	0	0	0	0	46	46	46	46	46	92	92	100	5#
	6#	0	0	0	0	0	46	46	46	46	46	92	100	6#
	0	0	0	0	0	0	0	0	0	10	10	10	10	

(H) Main Boom Load Chart

Unit: t

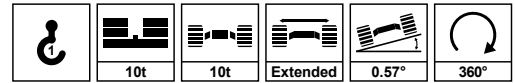





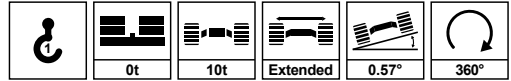

Main Boom Length (m)	Main Boom Length (m)												Main Boom Length (m)
	12.92	17.26	21.61	25.94	30.26	34.54	38.87	43.22	47.55	51.88	56.14	59.9	
3	94.8	94.8											3
3.5	94.8	94.8	89.6										3.5
4	94.8	87.3	76.0										4
4.5	84.2	74.4	65.7	60.3									4.5
5	72.0	64.6	57.6	53.4	50.1								5
5.5	62.6	56.8	51.0	47.8	45.2								5.5
6	55.2	50.5	45.7	43.1	41.0	39.4							6
7	42.8	41.0	37.4	35.7	34.4	33.4	30.9						7
8	33.5	34.1	31.2	30.1	29.4	28.8	26.7	25.3					8
9	27.1	27.8	26.5	25.8	25.4	25.1	23.3	22.2	21.4				9
10	22.3	23	22.7	22.4	22.2	22.1	20.6	19.6	18.9	17.5			10
11		19.4	19.1	19.6	19.5	19.6	18.2	17.4	16.9	16.6	14.1		11
12		16.5	16.3	17.0	17.3	17.5	16.3	15.6	15.2	14.9	14.1	12.2	12
13		14.2	13.9	14.7	15.4	15.7	14.6	14.0	13.6	13.5	13.5	12.2	13
14		12.2	12.0	12.8	13.6	14.2	13.1	12.6	12.3	12.2	12.3	11.6	14
16			9.0	9.8	10.6	11.3	10.7	10.3	10.1	10.1	10.2	9.9	16
18			6.8	7.5	8.3	9.1	8.7	8.4	8.3	8.4	8.6	8.4	18
20				5.8	6.6	7.3	7.0	6.9	6.9	7.0	7.2	7.1	20
22				4.4	5.2	6.0	5.6	5.6	5.7	5.9	6.1	6.0	22
24					4.1	4.8	4.5	4.4	4.6	4.9	5.2	5.1	24
26					3.1	3.9	3.5	3.5	3.7	4.0	4.3	4.3	26
28						3.1	2.7	2.7	2.9	3.2	3.6	3.5	28
30						2.4	2.0	2.0	2.2	2.5	2.9	2.9	30
32						1.8	1.5	1.5	1.6	1.9	2.3	2.4	32
34									1.1	1.4	1.8	1.8	34
36										1.0	1.3	1.4	36
38												1.0	38
40													40
	10	10	10	7	6	5	4	3	3	2	2	2	
	2#	0	0	46	46	46	46	92	92	92	92	100	2#
	3#	0	46	46	46	46	46	46	92	92	92	100	3#
	4#	0	0	0	46	46	46	46	46	92	92	100	4#
	5#	0	0	0	0	46	46	46	46	46	92	100	5#
	6#	0	0	0	0	0	46	46	46	46	46	92	6#
	0	0	0	0	0	0	0	12	30	30	40	40	

(H) Main Boom Load Chart

Unit: t



 m	Main Boom Length (m)												 m	
	12.92	17.26	21.61	25.94	30.26	34.54	38.87	43.22	47.55	51.88	56.14	59.9		
3	94.8	94.8												3
3.5	94.8	80.7	68.6											3.5
4	77.0	66.8	57.8											4
4.5	64.0	56.7	49.7	45.7										4.5
5	54.4	48.9	43.3	40.3	38.0									5
5.5	47.0	42.7	38.1	35.8	34.1									5.5
6	41.2	37.8	33.9	32.1	30.8	29.7								6
7	31.8	30.2	27.3	26.3	25.5	25.0	22.9							7
8	24.5	24.8	22.5	21.9	21.5	21.3	19.6	18.4						8
9	19.4	20.2	18.8	18.5	18.4	18.4	16.9	15.9	15.4					9
10	15.6	16.4	15.8	15.7	15.8	16.0	14.7	13.9	13.5	13.2				10
11		13.6	13.3	13.5	13.7	14.0	12.8	12.2	11.8	11.7	11.7			11
12		11.3	11.1	11.6	12.0	12.3	11.3	10.7	10.4	10.4	10.4	10.1		12
13		9.4	9.2	10.0	10.5	10.9	9.9	9.4	9.2	9.2	9.3	9.0		13
14		7.9	7.7	8.5	9.2	9.7	8.8	8.3	8.2	8.2	8.4	8.1		14
16			5.3	6.1	6.9	7.6	6.8	6.5	6.4	6.5	6.7	6.6		16
18			3.5	4.3	5.1	5.9	5.3	5.0	5.0	5.2	5.4	5.3		18
20				3.0	3.7	4.5	4.1	3.9	3.9	4.1	4.3	4.2		20
22				1.9	2.6	3.4	3.1	2.9	2.9	3.1	3.4	3.4		22
24					1.7	2.5	2.2	2.0	2.1	2.4	2.7	2.6		24
26					1.0	1.8	1.4	1.3	1.4	1.7	2.0	2.0		26
28						1.1				1.1	1.4	1.4		28
 10	10	10	8	5	4	4	3	2	2	2	2	2	 10	
 2#	2#	0	0	46	46	46	46	92	92	92	92	92	100	2#
	3#	0	46	46	46	46	46	46	92	92	92	92	100	3#
	4#	0	0	0	46	46	46	46	46	92	92	92	100	4#
	5#	0	0	0	0	46	46	46	46	46	92	92	100	5#
	6#	0	0	0	0	0	46	46	46	46	46	92	100	6#
 Min	0	0	0	0	0	0	28	38	50	50	50	55	 Min	

(H) Main Boom Load Chart

Unit: t

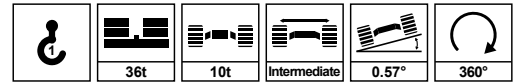

m	Main Boom Length (m)												m
	12.92	17.26	21.61	25.94	30.26	34.54	38.87	43.22	47.55	51.88	56.14	59.9	
3	94.8	94.8											3
3.5	94.8	94.8	89.9										3.5
4	94.8	94.8	89.9										4
4.5	94.8	94.8	85.9	79.3									4.5
5	93.4	84.6	76.5	71.2	55.0								5
5.5	82.7	75.6	68.8	64.5	55.0								5.5
6	74.1	68.2	62.4	58.8	55.0	44.0							6
7	57.7	56.6	52.2	49.8	47.9	41.8	35.7						7
8	46.6	47.0	44.6	42.9	41.5	40.1	33.1	29.3					8
9	38.6	39.2	38.7	37.4	36.5	35.8	30.9	28.0	22.8				9
10	32.7	33.3	32.9	33.0	32.4	32.0	28.8	26.2	22.8	17.5			10
11		28.7	28.3	29.0	29.0	28.8	27.0	24.6	21.6	17.5	14.1		11
12		25.0	24.7	25.4	26.1	26.0	24.6	23.2	20.5	17.5	14.1	12.2	12
13		22.0	21.7	22.4	23.1	23.7	22.4	21.6	19.5	16.9	14.1	12.2	13
14		19.5	19.2	19.9	20.7	21.4	20.5	19.7	18.6	16.1	13.9	11.6	14
16			15.3	16.0	16.7	17.5	17.1	16.7	16.4	14.7	12.9	9.9	16
18			12.3	13.0	13.8	14.5	14.1	14.1	14.1	13.5	12.1	8.6	18
20				10.7	11.5	12.2	11.9	11.8	12.0	12.2	11.3	7.6	20
22				8.9	9.7	10.4	10.0	10.0	10.2	10.4	10.6	6.7	22
24					8.1	8.9	8.5	8.5	8.7	9.0	9.3	5.9	24
26					6.9	7.6	7.3	7.2	7.4	7.7	8.1	5.3	26
28						6.5	6.2	6.2	6.4	6.6	7.0	4.7	28
30						5.6	5.3	5.3	5.4	5.7	6.1	4.2	30
32						4.8	4.5	4.5	4.7	4.9	5.3	3.8	32
34							3.8	3.8	4.0	4.3	4.6	3.4	34
36							3.2	3.2	3.4	3.6	4.0	3.1	36
38								2.6	2.8	3.1	3.5	2.8	38
40								2.1	2.3	2.6	3.0	2.5	40
42									1.9	2.2	2.5	2.2	42
44									1.5	1.8	2.1	2.0	44
46										1.4	1.8	1.8	46
48										1.1	1.4	1.5	48
50											1.1	1.2	50
C_n	10	10	10	9	6	5	4	4	3	2	2	2	C_n
2#	0	0	46	46	46	46	92	92	92	92	92	100	2#
3#	0	46	46	46	46	46	46	92	92	92	92	100	3#
4#	0	0	0	46	46	46	46	46	92	92	92	100	4#
5#	0	0	0	0	46	46	46	46	46	92	92	100	5#
6#	0	0	0	0	0	46	46	46	46	46	92	100	6#
Min	0	0	0	0	0	0	0	0	10	10	10	10	Min

(H) Main Boom Load Chart

Unit: t

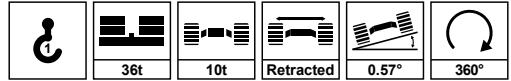

m	Main Boom Length (m)												m
	12.92	17.26	21.61	25.94	30.26	34.54	38.87	43.22	47.55	51.88	56.14	59.9	
6	57.3		49.2										6
7	45.1	44.9	41.4	39.7									7
8	36.7	37.3	35.5	34.3	33.4		30.7	29.2					8
9	30.6	31.2	30.8	30.0	29.4	29.0	27.2	26.0	22.8				9
10	25.9	26.6	26.2	26.4	26.1	25.9	24.3	23.3	22.6	17.5			10
11		22.9	22.6	23.3	23.3	23.2	21.9	21.0	20.4	17.5	14.1		11
12		19.9	19.6	20.3	21.0	21.0	19.8	19.0	18.5	17.5	14.1	12.2	12
13		17.4	17.2	17.9	18.6	19.1	17.9	17.3	16.9	16.7	14.1	12.2	13
14		15.4	15.2	15.8	16.6	17.3	16.4	15.7	15.4	15.3	13.9	11.6	14
16			11.9	12.6	13.3	14.1	13.7	13.2	13.0	13.0	12.9	9.9	16
18			9.4	10.1	10.9	11.6	11.2	11.2	11.0	11.1	11.2	8.6	18
20				8.2	9.0	9.7	9.3	9.3	9.4	9.5	9.7	7.6	20
22				6.6	7.4	8.1	7.8	7.7	7.9	8.2	8.4	6.7	22
24					6.1	6.8	6.5	6.5	6.6	6.9	7.3	5.9	24
26					5.0	5.8	5.4	5.4	5.6	5.9	6.2	5.3	26
28						4.8	4.5	4.5	4.7	5.0	5.3	4.7	28
30						4.1	3.7	3.7	3.9	4.2	4.5	4.2	30
32						3.4	3.0	3.0	3.2	3.5	3.9	3.8	32
34							2.4	2.4	2.6	2.9	3.3	3.3	34
36							1.9	1.9	2.1	2.4	2.7	2.8	36
38								1.4	1.6	1.9	2.3	2.3	38
40								1.0	1.2	1.5	1.8	1.9	40
42										1.1	1.5	1.5	42
44											1.1	1.2	44
46													46
	7	5	6	5	4	4	4	4	3	2	2	2	
2#	0	0	46	46	46	46	92	92	92	92	92	100	2#
3#	0	46	46	46	46	46	46	92	92	92	92	100	3#
4#	0	0	0	46	46	46	46	46	92	92	92	100	4#
5#	0	0	0	0	46	46	46	46	46	92	92	100	5#
6#	0	0	0	0	0	46	46	46	46	46	92	100	6#
	0	0	0	0	0	0	0	0	20	20	20	20	



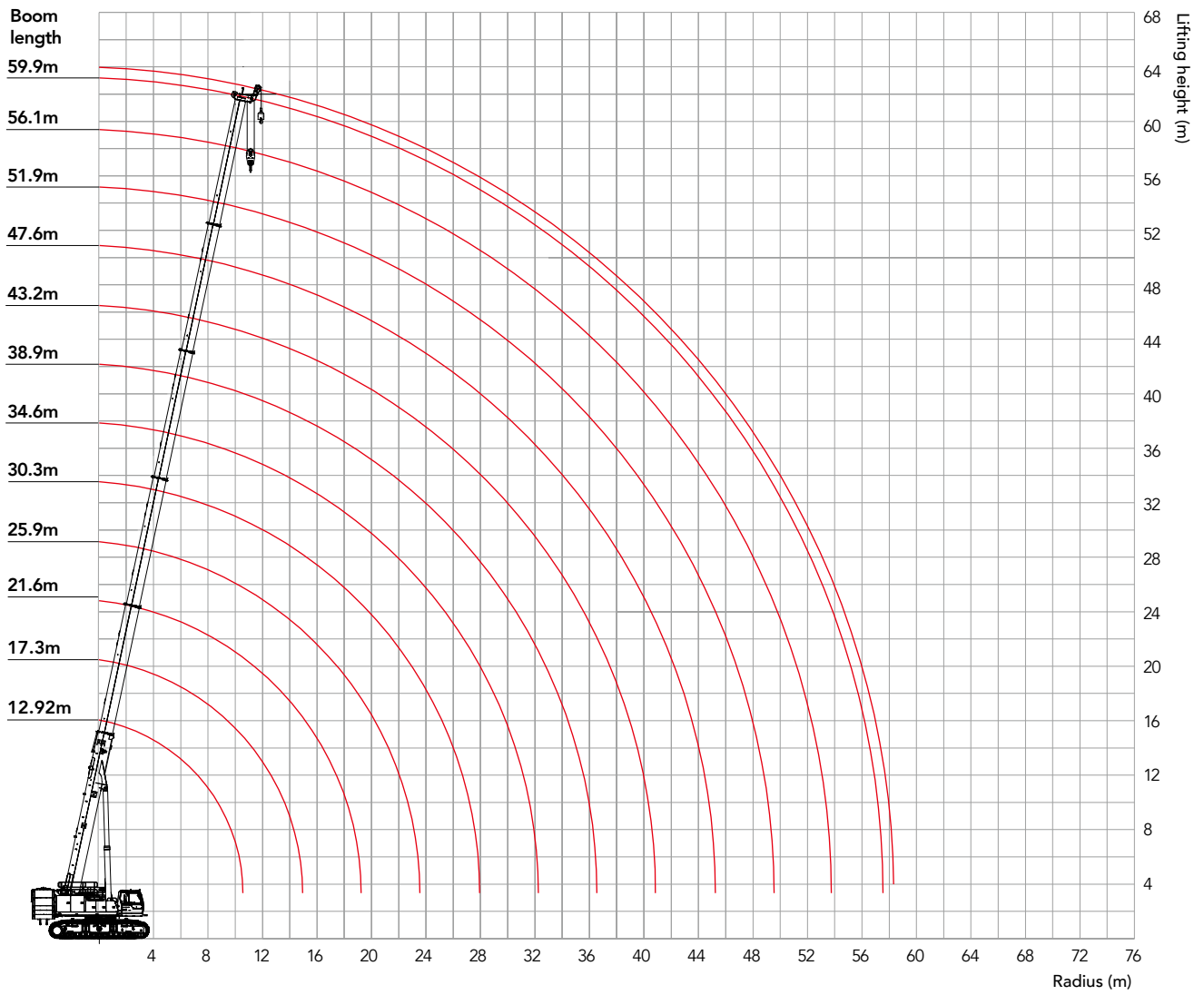

(HC) Auxiliary Lifting Sheave Range Diagram

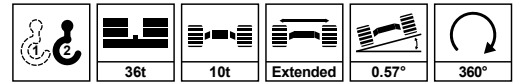

(HC) Auxiliary Lifting Sheave Load Chart

Unit: t



 m	Main Boom Length (m)												 m	
	12.92	17.26	21.61	25.94	30.26	34.54	38.87	43.22	47.55	51.88	56.14	59.9		
3	9.5	9.5												3
3.5	9.5	9.5												3.5
4	9.5	9.5	9.5											4
4.5	9.5	9.5	9.5											4.5
5	9.5	9.5	9.5	9.5										5
5.5	9.5	9.5	9.5	9.5	9.5									5.5
6	9.5	9.5	9.5	9.5	9.5									6
7	9.5	9.5	9.5	9.5	9.5	9.5								7
8	9.5	9.5	9.5	9.5	9.5	9.5	9.5							8
9	9.5	9.5	9.5	9.5	9.5	9.5	9.5	9.5						9
10	9.5	9.5	9.5	9.5	9.5	9.5	9.5	9.5	9.5	9.5				10
11		9.5	9.5	9.5	9.5	9.5	9.5	9.5	9.5	9.5	9.5			11
12		9.5	9.5	9.5	9.5	9.5	9.5	9.5	9.5	9.5	9.5	9.5		12
13		9.5	9.5	9.5	9.5	9.5	9.5	9.5	9.5	9.5	9.5	9.5	9.5	13
14		9.5	9.5	9.5	9.5	9.5	9.5	9.5	9.5	9.5	9.5	9.5	9.5	14
16			9.5	9.5	9.5	9.5	9.5	9.5	9.5	9.5	9.5	9.5	9.3	16
18			9.5	9.5	9.5	9.5	9.5	9.5	9.5	9.5	9.5	9.5	8.0	18
20				9.5	9.5	9.5	9.5	9.5	9.5	9.5	9.5	9.5	7.0	20
22					9.5	9.5	9.5	9.5	9.5	9.5	9.5	9.5	6.1	22
24						9.2	9.5	9.5	9.5	9.5	9.5	9.3	5.3	24
26						7.7	8.5	8.1	8.1	8.2	8.5	8.5	4.7	26
28							7.2	6.9	6.8	7.0	7.3	7.6	4.1	28
30							6.2	5.8	5.8	6.0	6.3	6.6	3.6	30
32								4.9	4.9	5.1	5.4	5.7	3.2	32
34								4.1	4.1	4.3	4.6	4.9	2.8	34
36								3.4	3.4	3.6	3.9	4.2	2.5	36
38									2.8	3	3.3	3.6	2.2	38
40									2.2	2.4	2.7	3.0	1.9	40
42										1.9	2.2	2.5	1.6	42
44										1.4	1.7	2.1	1.4	44
46											1.3	1.7	1.2	46
48											1.0	1.3	1.0	48
50												1.0	0.8	50
52												0.6	0.7	52
54													0.4	54
 Σ_n	1	1	1	1	1	1	1	1	1	1	1	1	1	 Σ_n
 2#	0	0	46	46	46	46	92	92	92	92	92	92	100	2#
3#	0	46	46	46	46	46	46	46	92	92	92	92	100	3#
4#	0	0	0	46	46	46	46	46	46	92	92	92	100	4#
5#	0	0	0	0	46	46	46	46	46	46	92	92	100	5#
6#	0	0	0	0	0	46	46	46	46	46	46	92	100	6#



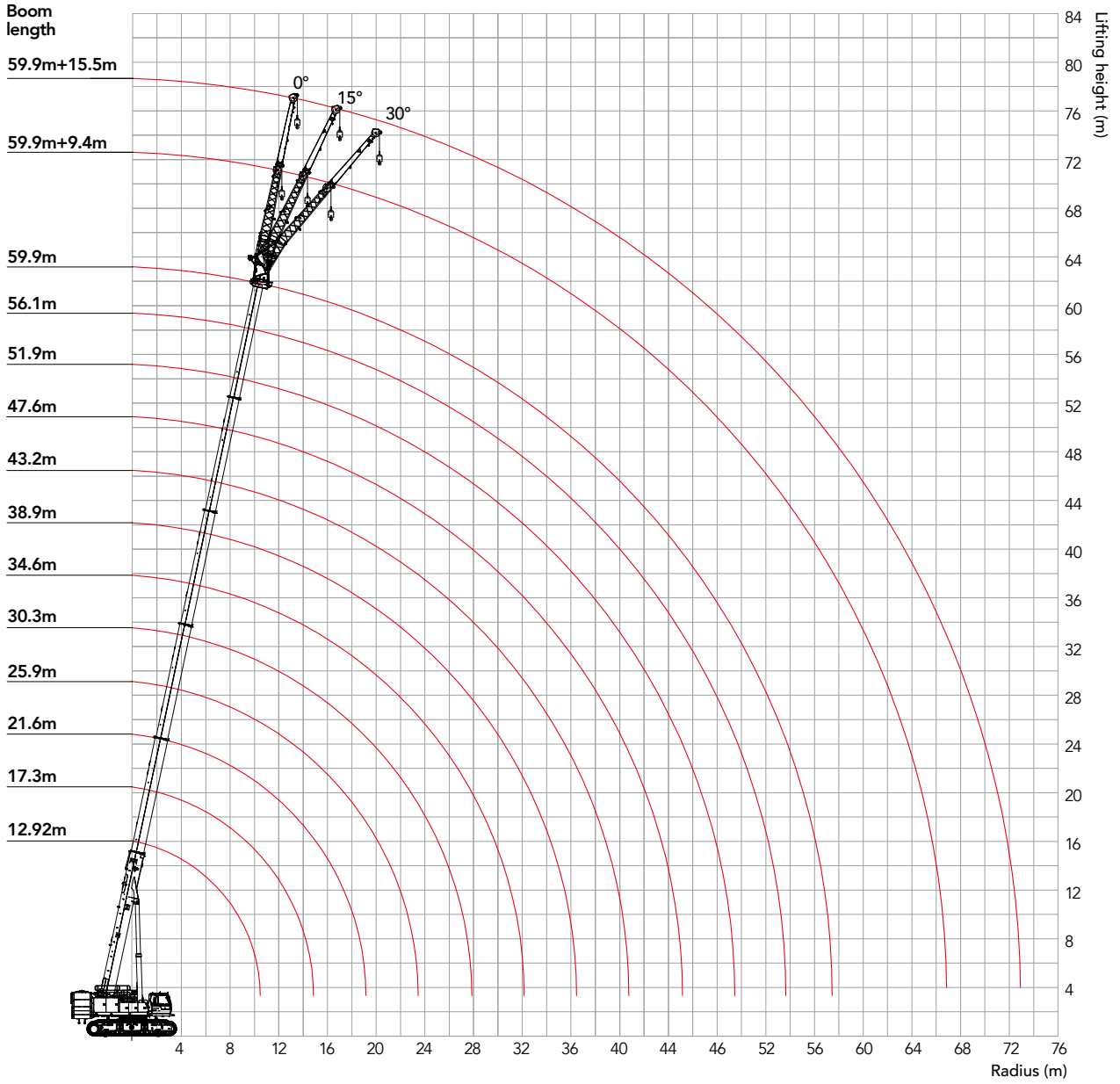



(FJ) Fixed Jib Range Diagram



(FJ) Fixed Jib Load Chart

Unit: t





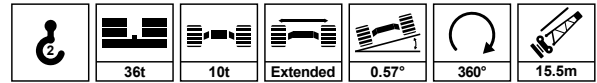

	Main Boom Length (m)				
	59.9				
	0°	15°	30°		
14	6.5			14	
16	6.5			16	
18	6.0	5.4		18	
20	5.5	5.4	5.0	20	
22	5.5	5.2	4.8	22	
24	5.3	5.2	4.6	24	
26	5.3	5.0	4.4	26	
28	5.2	4.8	4.2	28	
30	5.0	4.4	4.0	30	
32	4.8	4.3	3.9	32	
34	4.6	4.2	3.9	34	
36	4.0	4.0	3.8	36	
38	3.5	3.8	3.7	38	
40	3.0	3.3	3.4	40	
42	2.7	2.9	3.0	42	
44	2.6	2.5	2.8	44	
46	2.2	2.2	2.4	46	
48	1.9	1.9	2.1	48	
50	1.6	1.8	1.8	50	
52	1.3	1.5	1.5	52	
54		1.3	1.2	54	
	1	1	1		
	2#	100	100	100	
	3#	100	100	100	
	4#	100	100	100	
	5#	100	100	100	
	6#	100	100	100	

(FJ) Fixed Jib Load Chart

Unit: t



	Main Boom Length (m)			
	59.9			
	0°	15°	30°	
16	3.5			16
18	3.5			18
20	3.4	3.2		20
22	3.4	3.2		22
24	3.3	3.1	3.0	24
26	3.3	3.1	3.0	26
28	3.3	3.1	3.0	28
30	3.2	3.0	3.0	30
32	3.2	3.0	3.0	32
34	3.2	3.0	2.9	34
36	3.1	2.9	2.9	36
38	3.1	2.9	2.9	38
40	3.0	2.9	2.9	40
42	2.8	2.9	2.9	42
44	2.7	2.6	2.7	44
46	2.3	2.5	2.5	46
48	2.3	2.5	2.4	48
50	2.0	2.0	2.3	50
52	1.7	1.9	2.1	52
54	1.4	1.6	1.8	54
56	1.2	1.3	1.6	56
58	1.1	1.2	1.3	58
60		1.1	1.1	60
	1	1	1	
	2#	100	100	2#
	3#	100	100	3#
	4#	100	100	4#
	5#	100	100	5#
	6#	100	100	6#



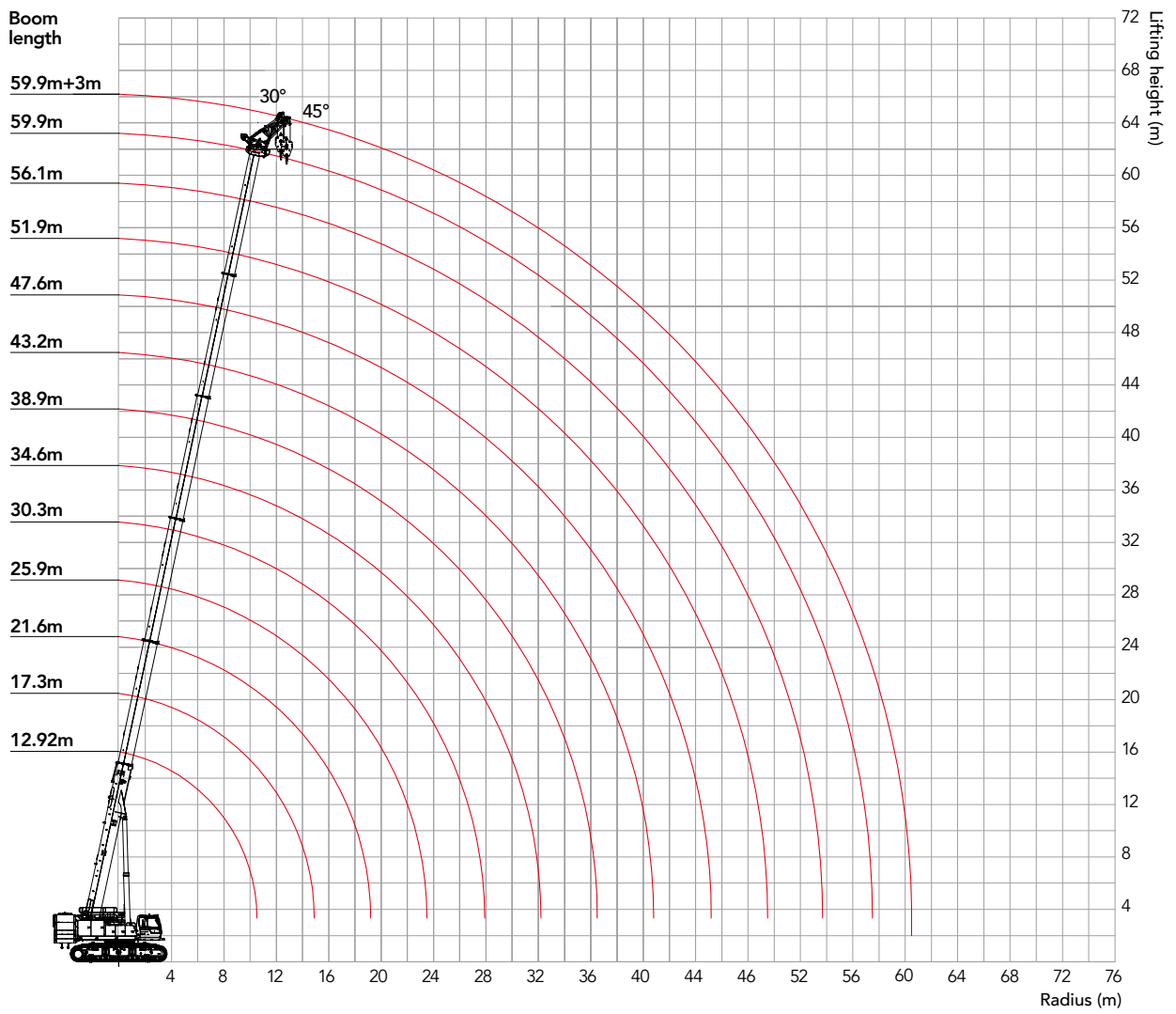



(FJh) Heavy Duty Jib Range Diagram

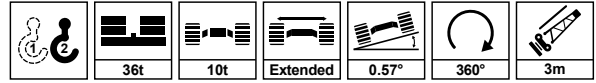







(FJh) Heavy Duty Jib Load Chart

Unit: t









	Main Boom Length (m)													
	12.92		17.26		17.25		17.24		21.61		21.6			
	30°	45°	30°	45°	30°	45°	30°	45°	30°	45°	30°	45°		
3.5	35.6	35.6	35.6	35.6	35.6	35.6	35.6	35.6	35.6					3.5
4	35.6	35.6	35.6	35.6	35.6	35.6	35.6	35.6	35.6	35.6	35.6	35.6	35.6	4
4.5	35.6	35.6	35.6	35.6	35.6	35.6	35.6	35.6	35.6	35.6	35.6	35.6	35.6	4.5
5	35.8	35.6	35.6	35.6	35.6	35.6	35.6	35.6	35.6	35.6	35.6	35.6	35.6	5
5.5	34.8	33.8	35.6	35.6	35.6	35.6	35.6	35.6	35.6	35.6	35.6	35.6	35.6	5.5
6	33.9	33.0	35.6	35.6	35.6	35.6	35.6	35.6	35.6	35.6	35.6	35.6	35.6	6
7	33.1	32.3	35.6	35.3	35.6	35.3	35.6	35.3	35.6	35.6	35.6	35.6	35.6	7
8	31.7	31.2	35.0	34.0	35.0	34.0	35.0	34.0	35.6	35.6	35.6	35.6	35.6	8
9	30.7		33.7	32.8	33.7	32.8	33.7	32.8	35.6	35.2	35.6	35.2	35.6	9
10	30.1		32.5	31.9	32.5	31.9	32.5	31.9	35.1	34.1	35.1	34.1	35.6	10
11			31.6	31.1	31.6	31.1	31.6	31.1	34.0	33.2	34.0	33.2	35.6	11
12			30.8		30.8		30.8		30.9	31.4	31.9	32.3	35.6	12
13			27.8		28.3		28.7		27.2	27.6	28.1	28.4	35.6	13
14									24.1		24.9		35.6	14
16									19.2		20.1		35.6	16
	4	4	4	4	4	4	4	4	4	4	4	4		
	2#	0	0	0	0	0	0	0	46	46	0	0		
	3#	0	0	46	46	0	0	0	46	46	46	46		
	4#	0	0	0	0	46	46	0	0	0	46	46		
	5#	0	0	0	0	0	0	46	46	0	0	0		
	6#	0	0	0	0	0	0	0	0	0	0	0		
	6#	0	0	0	0	0	0	0	0	0	0	0		

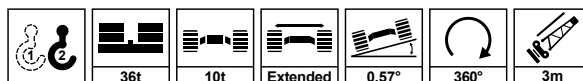



	Main Boom Length (m)													
	21.5		25.94		25.93		25.84		30.28		30.26			
	30°	45°	30°	45°	30°	45°	30°	45°	30°	45°	30°	45°		
4	35.6	35.6												4
4.5	35.6	35.6												4.5
5	35.6	35.6												5
5.5	35.0	35.6	35.6	35.6	35.6	35.6	35.6	35.6						5.5
6	33.7	35.6	35.6	35.6	35.6	35.6	35.6	35.6	35.6	35.6	35.6	35.6	35.6	6
7	32.4	35.6	35.6	35.6	35.6	35.6	35.0	35.0	35.6	35.6	35.6	35.6	35.6	7
8	30.2	35.6	35.6	35.6	35.6	35.6	32.9	32.9	35.6	35.6	35.6	35.6	35.6	8
9	28.3	35.3	35.6	35.6	35.6	35.6	31.0	31.0	34.6	34.6	34.6	34.6	34.6	9
10	26.4	34.0	35.6	35.6	35.6	35.6	29.3	29.3	32.1	32.1	32.1	32.1	32.1	10
11	24.6	32.8	34.9	35.0	35.4	35.0	27.8	27.8	30.1	30.1	30.1	30.1	30.1	11
12	23.0	31.9	31.0	31.6	31.6	32.1	26.0	26.0	28.1	28.1	28.1	28.1	28.1	12
13	21.7	29.7	27.5	27.9	27.9	28.3	24.5	24.5	26.1	26.1	26.1	26.1	26.1	13
14	20.4		24.4	24.7	24.8	25.1	23.1	23.1	24.1	24.2	24.2	24.2	24.2	14
16	19.4		19.5	19.8	19.9	20.2	21.3	21.6	19.5	19.8	20.0	20.3	20.3	16
18			15.9		16.3		17.7		15.9	16.1	16.4	16.6	16.6	18
20			13.2		13.5		14.9		13.1		13.6			20
22									10.8		11.3			22
	4	4	4	4	4	4	4	4	4	4	4	4		
	2#	0	0	46	46	0	0	0	46	46	46	46		
	3#	0	0	46	46	92	92	0	92	92	46	46		
	4#	0	0	46	46	46	46	46	46	46	46	46		
	5#	46	46	0	0	0	0	46	46	0	0	46		46
	6#	46	46	0	0	0	0	46	46	0	0	0		0
	6#	46	46	0	0	0	0	46	46	0	0	0		0

(FJh) Heavy Duty Jib Load Chart

Unit: t







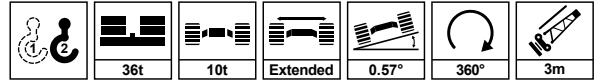

	Main Boom Length (m)													
	30.19		34.61		34.54		34.53		38.87		38.86			
	30°	45°	30°	45°	30°	45°	30°	45°	30°	45°	30°	45°		
6	35.6	35.6											6	
7	35.6	35.6	26.9	26.9	26.9	26.9	26.9	26.9					7	
8	34.6	34.6	26.9	26.9	26.9	26.9	26.9	26.9	26.9	26.9	26.9	26.9	8	
9	32.8	32.8	26.9	26.9	26.9	26.9	25.2	25.2	26.9	26.9	26.2	26.2	9	
10	31.2	31.2	26.9	26.9	26.9	26.9	23.4	23.4	26.8	26.8	24.4	24.4	10	
11	29.8	29.8	26.8	26.8	26.9	26.9	21.8	21.8	25.1	25.1	22.9	22.9	11	
12	28.4	28.4	25	25	26.9	26.9	20	20	23.5	23.5	21.5	21.5	12	
13	26.8	26.8	23.4	23.4	26.9	26.9	18.4	18.4	22	22	20.3	20.3	13	
14	25.5	25.5	21.9	21.9	24.6	25	17	17	20.8	20.8	19.2	19.2	14	
16	21	21.3	19.2	19.6	20.4	20.8	15.8	15.8	19.3	19.6	18.2	18.2	16	
18	17.4	17.6	16	16.3	16.9	17.1	13.8	13.8	16.2	16.5	16	16	18	
20	14.6		13.2	13.4	14.1	14.3	12.1	12.1	13.6	13.9	14	14.2	20	
22	12.4		10.9	11.1	11.9	12.1	10.8	10.8	11.4	11.7	11.7	11.9	22	
24			9		10		9.7		9.5	9.7	9.8	10	24	
26			7.4		8.4		8.7		7.9		8.2		26	
28									6.6		6.9		28	
	4	4	3	3	3	3	3	3	3	3	3	3		
	2#	0	0	92	92	46	46	0	0	92	92	46	46	2#
	3#	46	46	46	46	46	46	92	92	46	46	92	92	3#
	4#	46	46	46	46	46	46	46	46	46	46	46	46	4#
	5#	46	46	46	46	46	46	46	46	46	46	46	46	5#
	6#	46	46	0	0	46	46	46	46	46	46	46	46	6#
	6#	46	46	0	0	46	46	46	46	46	46	46	46	6#

	Main Boom Length (m)													
	38.8		43.22		43.21		43.12		47.55		47.53			
	30°	45°	30°	45°	30°	45°	30°	45°	30°	45°	30°	45°		
8	24.4	24.4											8	
9	22.9	22.9	25.7	25.7	23.0	23.0	18.9	18.9					9	
10	21.6	21.6	24.5	24.5	21.7	21.7	17.8	17.8	18.8	18.8	18.7	18.7	10	
11	20.4	20.4	23.0	23.0	20.3	20.3	16.8	16.8	18.8	18.8	18.0	18.0	11	
12	19.4	19.4	21.6	21.6	19.1	19.1	15.9	15.9	18.8	18.8	17.2	17.2	12	
13	18.4	18.4	20.3	20.3	18.1	18.1	15.1	15.1	18.4	18.4	16.3	16.3	13	
14	17.6	17.6	19.2	19.2	17.1	17.1	14.4	14.4	17.5	17.5	15.5	15.5	14	
16	16.8	16.8	18.1	18.1	16.2	16.2	13.7	13.7	16.7	16.7	14.7	14.7	16	
18	15.4	15.4	15.6	15.9	14.6	14.6	12.6	12.6	15.1	15.1	13.4	13.4	18	
20	14.3	14.3	13.1	13.4	12.9	12.9	11.6	11.6	12.9	13.2	12.2	12.2	20	
22	12.3	12.4	11.1	11.4	11.5	11.5	10.8	10.8	10.9	11.2	10.8	10.8	22	
24	10.4	10.6	9.4	9.6	9.9	10.1	10.1	10.1	9.3	9.5	9.7	9.7	24	
26	8.8		7.8	8.0	8.3	8.5	9.0	9.2	7.9	8.1	8.5	8.7	26	
28	7.5		6.5	6.7	7.0	7.1	7.7	7.8	6.6	6.8	7.2	7.4	28	
30			5.4		5.8		6.5		5.5	5.6	6.0	6.2	30	
32			4.4		4.8		5.5		4.5	4.6	5.1	5.2	32	
34									3.6		4.2		34	
	3	3	3	3	3	3	2	2	2	2	2	2		
	2#	46	46	92	92	46	46	46	46	92	92	46	46	2#
	3#	46	46	92	92	92	92	46	46	92	92	92	92	3#
	4#	46	46	46	46	92	92	46	46	92	92	92	92	4#
	5#	46	46	46	46	46	46	92	92	46	46	92	92	5#
	6#	92	92	46	46	46	46	92	92	46	46	46	46	6#
	6#	92	92	46	46	46	46	92	92	46	46	46	46	6#

(FJh) Heavy Duty Jib Load Chart

Unit: t



	Main Boom Length (m)											
	47.46		51.88		51.8		56.14		59.9			
	30°	45°	30°	45°	30°	45°	30°	45°	30°	45°		
10	16.9	16.9										10
11	16.0	16.0	16.6	16.6	14.9	14.9						11
12	15.1	15.1	16.6	16.6	14.7	14.7	13.5	13.5				12
13	14.3	14.3	16.2	16.2	14.4	14.4	13.5	13.5	9.4	9.4		13
14	13.6	13.6	15.6	15.6	13.7	13.7	13.4	13.4	9.4	9.4		14
16	13.0	13.0	15.0	15.0	13.1	13.1	12.9	12.9	9.4	9.4		16
18	11.8	11.8	13.7	13.7	12.0	12.0	12.0	12.0	9.4	9.4		18
20	10.8	10.8	12.6	12.6	11.1	11.1	11.2	11.2	8.1	8.1		20
22	10.0	10.0	10.9	11.1	10.3	10.3	10.5	10.5	7.1	7.1		22
24	9.3	9.3	9.3	9.5	9.4	9.4	9.4	9.6	6.3	6.3		24
26	8.6	8.6	7.9	8.1	8.4	8.4	8.0	8.2	5.6	5.6		26
28	7.7	7.8	6.7	6.9	7.5	7.6	6.9	7.0	5.0	5.0		28
30	6.5	6.7	5.7	5.8	6.4	6.5	5.8	6.0	4.4	4.4		30
32	5.5	5.7	4.7	4.8	5.4	5.5	4.9	5.1	4.0	4.0		32
34	4.7		3.8	4.0	4.5	4.6	4.2	4.3	3.6	3.6		34
36			3.1		3.7		3.4	3.5	3.2	3.2		36
38			2.4		3.1		2.7	2.8	2.7	2.8		38
40							2.1		2.1	2.2		40
42									1.6			42
44									1.1			44
	2	2	2	2	2	2	2	2	2	2	2	
	2#	46	46	92	92	46	46	92	92	100	100	
	3#	46	46	92	92	92	92	92	92	100	100	
	4#	92	92	92	92	92	92	92	92	100	100	
	5#	92	92	92	92	92	92	92	92	100	100	
	6#	92	92	46	46	92	92	92	92	100	100	



Zhejiang Sany Equipment Co.,LTD

SANY Crawler Crane Industrial Park, No. 2188 Daishan Road, Wuxing District, Huzhou City,
Zhejiang Province, P. R. China Zip 313028
Consulting sanycrane@sanygroup.com (Crane BU) / crd@sany.com.cn (IHQ)
After-sales Service 0086-400 6098 318

Reminder:

Any change in the technical parameters and configuration due to product modification or upgrade may occur without prior notice.
The machine in the picture may include additional equipment. This brochure is for reference only, and goods in kind shall prevail.
Copyright at SANY. No part of this brochure may be copied or used for any purpose without written approval from SANY.

© Edited in March 2024

