

# SCE12500A

## Crawler Crane

Quality Changes the World



**Max. lifting moment: 19800t·m**  
**Max. boom length: 108m**  
**Max. luffing jib combination: 108m+114m**

The parameters, pictures and standard/optional equipment are only for reference in this brochure, the actual machine is based on the effective price list and contract.



**Crawler Crane Series**  
**SCE12500A**

P03

Main  
Characteristics

- Product Specifications
- Safety Device

P10

Technical  
Parameters

- Main performance Parameters
- Outline Dimension
- Transportation Dimensions
- Assembly Procedure

P24

Configurations

- Configuration
- H Configuration
- HDB Configuration
- HJ Configuration
- HJDB Configuration
- LJ Configuration
- LJDB Configuration
- HJFJDB Configuration



## **SCE12500A SANY CRAWLER CRANE**

QUALITY CHANGES THE WORLD

### Main Characteristics

- Page 04 Product specifications
- Page 08 Safety device



## Product Specification



### Appearance

- The industrial modeling of the cab is designed by Porsche. It has a smooth, elegant and novel appearance, which is a significant breakthrough when compared with traditional engineering machinery and has excellent brand identification. The cab has a sliding door structure, which is suitable for the crawler crane and convenient for the operator. It is adopted with fully-sealed steel frame structure with a large area of high strength toughened glass installed on the front, side and top, transmitting more light. The interior space of the cab is spacious and bright, with a broader sight view.

### Comfort

- It is adopted with shock absorption, noise reduction, suspended, multi-mode and multi-stage adjustable seat, thus providing the operator with the most comfortable driving experience. The famous USA RedDot air conditioner is adopted, ensuring more reasonable air outlet and efficient cooling. It takes no more than 20 min to cool the cab from 55°C to 27.5°C. The left and right consoles are equipped with control handles, control buttons, ignition locks and other elements. The seats, control handles and control buttons are arranged according to ergonomic design, fully considering the driver's operation demands and habits. The control box can be adjusted to the most suitable position with the seat to ensure more comfortable operation. The cab can tilt up to 15° according to the work demands, and can also rotate to the front part of the rotating bed for the convenience of transport.

### Carbody

- The hydraulic cylinder driving power pin is connected with the crawler frame for easy assembly and disassembly. The high-strength steel welded frame structure is adopted. Larger carbody design significantly improves the stability of the overall crane. The carbody counterweight is 90t, 45t each at front and back.

### Crawler assembly

- Crawler frames: each crawler frame is equipped with independent traveling driving devices. The planetary gear reducer is driven by the hydraulic traveling motor, and independent traveling is realized through the transmission of the driving gear. The driving system has two speed positions, namely high speed and low speed: The low speed can provide sufficient traction force to realize 100% travel with load; the high speed can provide higher speed to improve the transit efficiency. The traveling drive can also realize stepless speed change.
- Track shoe: It is made of materials with high strength and high wear resistance through advanced casting process. After being installed on the equipment, its tension can be adjusted through the hydraulic cylinder, and the shim position can be adjusted to achieve the ideal tension.

### One-key leveling of outriggers

- With the machine gravity calculated in real time, the outrigger balance is detected by the cylinder pressure sensor, the outriggers can be adjusted to level state by one key to reduce assembly time and improve efficiency.





## Product Specification

### Engine

- Mercedes-Benz: Euro Tier V.
- Rated power: 2×298 kW.
- Rated speed: 1800 rpm.
- Maximum output torque: 2100 N·m.
- Speed at the maximum output torque: 1300 rpm.

### Load hoist winch mechanism

- The planetary gear box driven by hydraulic motor of variable displacement is used to control the main load hoist I and main load hoist II to lift and lower the load. It provides good inching performance, and also ensures quick powered lifting of main load hoist winches.
- The maximum number of parts of line is 62. The multilayer winding of rope-folding drum ensures no rope disorder. The gear box is featured in low noise, high efficiency, long service life and easy access to oil change.

Main load hoist winches W1-1 and W1-2	Speed of rope in the outermost working layer	0~140m/min
	Diameter of wire rope	32mm
	Rope length	1800m
	Rated single line pull	23.5t
Auxiliary load hoist winch W2	Speed of rope in the outermost working layer	140m/min
	Diameter of wire rope	28mm
	Rope length	600m
	Rated single line pull	17.2t

### Boom hoist winch mechanism

- Components: Boom luffing mechanism, jib luffing mechanism, superlift luffing mechanism.
- All luffing winches adopt fold-line drums, which are driven by hydraulic motor through the planetary gear box and can realize a number of compound actions and good inching performance.

Boom luffing mechanism W3	Speed of rope in the outermost working layer	65×2m/min
	Diameter of wire rope	32mm
Jib luffing mechanism W4	Speed of rope in the outermost working layer	0~130m/min
	Diameter of wire rope	32mm
Superlift luffing mechanism W5	Speed of rope in the outermost working layer	140m/min
	Diameter of wire rope	32mm

### Slewing mechanism

- The slewing hydraulic system adopts double motor to drive the spur gear through the planetary gear box, which can realize 360° rotation, slewing speed of 0~0.9 rpm, stepless speed regulation, no backlash at starting or stopping, stable operation and free slipping function at neutral position. Slewing ring: It is adopted with three-row roller type slewing bearing with external gears. The main unit can be separated from the lower structure through the adaptor ring.

## Product Specification



- The operating equipment is made of high-strength steel tubes and high-strength steel plates, and the rolled welded pulleys are adopted on the boom head and hook.

### Boom

- The boom is a spatial lattice structure of welded tubes with equal section areas of inserts and tapered sections for two ends. The boom top and root are strengthened with steel plates, which is easier for load transfer.
- The boom length is 111m, 30m (basic boom)~108m (with superlift), 3m boom insert used in non boom configuration.
- Compositions: Boom base 10.5m, 1 transition section of 12 m, 1 connecting tip of 1.5m, 1 insert of 3m, 2 inserts of 6m, and 6 inserts of 12m boom top pulley block.
- The extension jib is installed on the boom top.

### Fixed jib

- The fixed jib is a spatial lattice structure of welded tubes with equal section areas of inserts and tapered sections for two ends. The jib top and root are strengthened with steel plates, which is easier for load transfer.
- The length of the fixed jib is 12m.
- Compositions: Jib base 6m×1, jib top 6m×1.

### Luffing jib

- The luffing jib is a spatial lattice structure of welded tubes with equal section areas of inserts and tapered sections for two ends. The jib top and root are strengthened with steel plates, which is easier for load transfer.
- The length of the luffing jib is 30m~114m.
- Compositions: Jib base 10.5m×1, boom insert (H8D)12m×1, tapered section 6m×1, insert 6m×2, insert 12m×6, jib top 1.5m×1.
- The extension jib is installed on the jib top.

### Superlift device

- The superlift mast is a spatial lattice structure of welded tubes with equal section areas of inserts and tapered sections for two ends. The mast base and top are strengthened with steel plates, which is easier for load transfer.
- The length of the superlift mast is 42m.
- Compositions: Superlift base 12m×1, insert 6m×1, insert 12m×1, top 12m×1.

### Hook

- There are 4 types of hook available. The specific parameters are as follows:

Hook	Maximum lifting capacity	Quantity	Number of pulleys	Unit weight (t)
1250t hook (decomposable)	1250t	1	2×14	30.6
800t hook (dual pulley block)	800t	1	2×11	24.1
250t hook (dual pulley block)	250t	1	2×3	15.5
25t ball hook (no pulley)	25t	1	0	1.7

Note: The 1250t hook can be decomposed into 650t hook.

### Hook limitation height

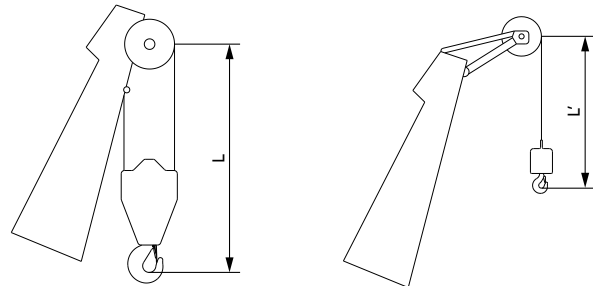

Hook	L
1250t	10.38m
800t	8.4m
250t	7.26m

Hook	L'
25t	6.3m



## Product Specification

### Additional device

- Lower structure jack cylinders.
- Portable power pack.

### Counterweight

- The counterweight includes the carbody counterweight, rear counterweight, superlift counterweight, and the specific parameters are as follows:

Name	Quantity	Length (m)	Width (m)	Height (m)	Unit weight (t)
Carbody counterweight	6	2.40	2.85	0.484	10
Carbody counterweight tray	2	3.00	3.666	1.465	15
Rear counterweight	22	2.40	2.85	0.484	10
Rear counterweight tray	2	3.35	2.86	2.96	15
Superlift counterweight	52	2.40	2.85	0.484	10
Superlift counterweight tray	1	10.124	3.00	1.014	30

### Hydraulic system

- Hydraulic system includes load hoist hydraulic system, traveling hydraulic system, slewing hydraulic system, boom hoist hydraulic system, servo hydraulic system, back-stop hydraulic system, cooling system, auxiliary hydraulic system. The main hydraulic components are original parts imported.
- Characteristics: The load hoisting, traveling, boom hoist and slewing hydraulic systems are of closed loop type, featuring energy saving, high efficiency, quick response, low heat radiation and long service life.
- The servo system adopts electrical proportional control components to facilitate the accurate and intelligent control.
- The back-stop hydraulic system adopts balance valve of external control and unloading, and it is mounted on the cylinder to make sure it is safe and reliable.
- The cooling system is characterized by higher power and quicker cooling.

### Working weight

- The working weight is about 777t, including superstructure, lower structure, rear counterweight, carbody counterweight, 30m base boom and 1250t hook.

### Ground pressure

- The average ground bearing pressure of the crane with base boom is 0.14 MPa.

### Gradeability

- The gradeability of the crane with base boom is 20%.

## Safety Devices



### Load moment indicator

- The proprietary load moment limiter independently developed by Sany is adopted, which forms a network with other controllers through CAN bus line, so as to realize safe and reliable control. The load moment limiter can automatically detect the hoisting weight of the crane and the angle of the boom, and display the rated load capacity, actual load, working radius, and the allowable height of the hook.
- The load moment limiter system consists of a large-screen color display, a host computer, angle sensors, tension sensors, pressure sensors and other components.

### Over-hoist protection of the main and auxiliary hooks

- It is used to prevent the over-hoist of the hook. When the lifting hook is raised to a certain height, the limit switch will start working, and hook will be automatically cut off from moving up by the control system. Meanwhile, the display and the buzzer will give alarms. At this moment, only hook lowering is allowed to prevent over-hoist action.

### Over-release protection device of the main and auxiliary hook

- It is used to prevent the wire rope over-release. When the wire rope is released to the last three wraps, the limit switch will start working, and the releasing of rope will be automatically stopped by the control system. Meanwhile, the display and the buzzer will give alarms. At this moment, only rope retraction is allowed to prevent over release action.

### Boom angle limit

- When the elevation angle of the boom exceeds 85° or jib angle exceeds 75°, corresponding limit switch will be triggered, and the control system will automatically cut off the boom hoisting. Meanwhile, the display and the buzzer will give alarm. At this moment, boom/jib luffing winch won't hoist but it can still lower down.
- When the boom down angle is less than 30° or jib down angle is less than 15°, the control system will automatically cut off the boom/jib from further lowering. Meanwhile, the display and the buzzer will give alarms. At this moment, boom/jib luffing winch won't be able to lower. This protection is automatically controlled by Load Moment Limiter.

### Back-stop device

- The boom and the superlift mast are respectively equipped with a pair of back-stop cylinders. The high pressure of the cylinder shall be overcome when the boom tilts backwards, and high pressure oil will be supplemented automatically when the boom slewing forwards to increase the tension and prevent the boom vibration and shaking back.
- The jib rear mast is equipped with a pair of back-stop cylinders, while the jib front mast is equipped with a pair of pneumatic cylinders to prevent the mast from the backward inclination and tension of the jib luffing wire rope.

### Brake of hoisting mechanism

- All hoisting brakes are spring loaded normally closed disc brakes, which are featured with large braking force, maintenance-free, safe and reliable use, and long service life.

### Closed circuit monitoring system

- It can be used to monitor the winding conditions of wire ropes of each hoisting mechanism, the conditions of superlift weight, and conditions around the equipment.
- Video recorder can store video as long as 76 hours.
- Machine operation can be recorded.

### Failure auto-diagnosis system

- Failure code can help troubleshooting easily.

## Safety Devices



### Black box

- It is able to record the operation data and machine movement, and analyze the remaining running conditions and service life of machine based on the actual performance.

### Pharos

- It is mounted on the top of the boom/jib and alerts in air during night.

### Anemometer

- It is mounted on the top of the boom/jib to monitor the wind speed in real time and display relative data on the monitor.

### Electronic level indicator

- It displays the tilting angle of the crane on the monitor in real time and protects the safe operation of the crane.

### Lightning protection device

- It includes the lightning protection device and the surge protection device, which can effectively protect the electric system elements and workers from lightning.

### Hook latch

- The lifting hook is installed with a baffle plate to prevent wire rope from falling off.

### Slewing and travel visual-audio alarm

- When the machine is slewing or traveling, the horn will send out alarm per certain frequency, and warning indicator light flashes, to warn the people around the machine. This can be turned off in the control system.

### Function lock

- The operation will be locked by pulling up the function locking lever on the right side of the seat inside the driver's cab or when the operator left the seat, after which no operating handles will be working so that improper operation caused by the body collision when getting on and off the crane can be avoided.

### Regulation of engine power ultimate load and stalling protection

- The controller can monitor the engine power so as to prevent stalling.

### Remote monitoring system

- It monitors and analyzes the operation data so as to realize remote diagnosis of faults and timely solution.

### Proactive safety control technology

- Slewing speed can be automatically reduced based on boom length to make it safer.
- Flexible safety protection reduces the speed when the mechanism approaches to the safety limit position, which ensures reliability.
- Real-time monitor of hydraulic oil temperature allows limits on the action speed based on oil temperature, which protect the hydraulic components effectively.
- The protection can be set on man-machine interface as customer needs.



## **SCE12500A SANY CRAWLER CRANE**

QUALITY CHANGES THE WORLD

### Technical Parameters

- Page 11 Main Performance Parameters
- Page 12 Outline Dimension
- Page 14 Transportation Dimensions
- page 23 Assembly Procedure

> 10



## Main Performance Parameters

Major Performance & Specifications of SCE12500A		
Performance indexes	Unit	Parameter
Maximum rated lifting capacity	t	844
Maximum rated lifting capacity (with superlift)	t	1250
Maximum rated lifting moment	t·m	5908
Maximum rated lifting moment (with superlift)	t·m	19800
Boom length	m	30~72
Boom length (with superlift)	m	42~108
Mixed boom length	m	48~78
Mixed boom length (with superlift)	m	84~171
Luffing jib length	m	36~66
Luffing jib length (with superlift)	m	30~114
Length of short fixed jib	m	12
Longest boom combination (LJDB working condition)	m	108+114
Boom luffing angle	°	30~85
Jib luffing angle	°	15~75
Maximum rope speed of single rope of main load hoist winch (outermost working layer)	m/min	140
Maximum rope speed of single rope of aux. load hoist winch (outermost working layer)	m/min	140
Maximum rope speed of single rope of boom hoist mechanism (outermost working layer)	m/min	65×2
Maximum rope speed of single rope of jib luffing mechanism (outermost working layer)	m/min	130
Maximum rope speed of single rope of superlift luffing mechanism (outermost working layer)	m/min	140
Slewing speed (no load)	r/min	0.9
Travelling speed	km/h	0~0.8
Gradeability (with basic boom, cab facing backward)	%	20
Rated output power of the engine	kW/r/min	2×298/1800
Machine weight (basic boom, 250t machine rear counterweight, 90t carbody counterweight, with 1250t hook)	t	777
Average ground bearing pressure of the crawler (base boom, 250t machine counterweight, 90t carbody counterweight, 1250t hook)	MPa	0.14
Rear counterweight (including tray)	t	250
Superlift counterweight (including tray)	t	550
Carbody counterweight (including tray)	t	90
Maximum transportat dimensions of single piece (L×W×H)	mm	15300×3500×3200
Maximum transport weight of single piece	t	54

### Outline Dimension

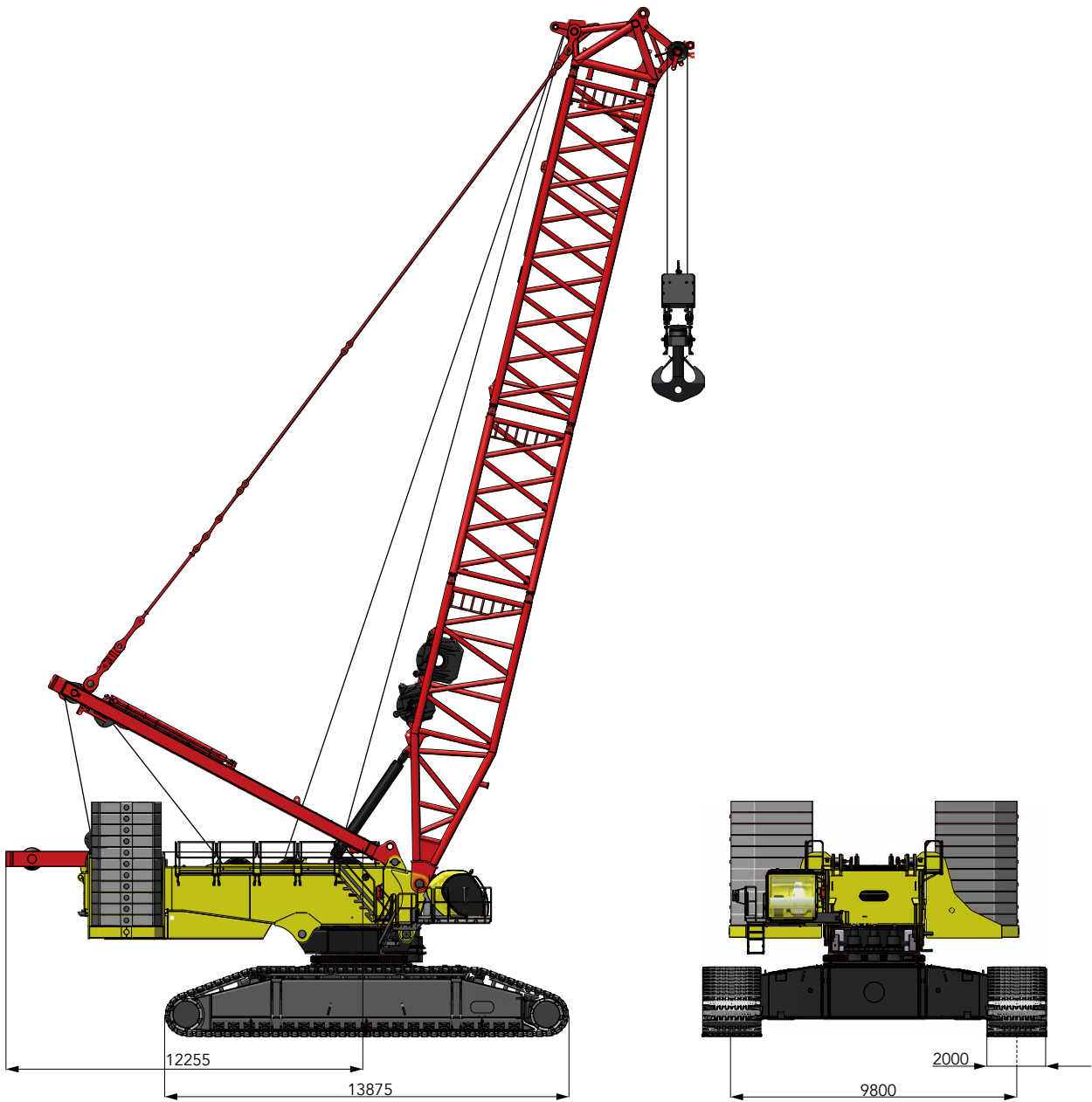

Unit: mm

## Outline Dimension

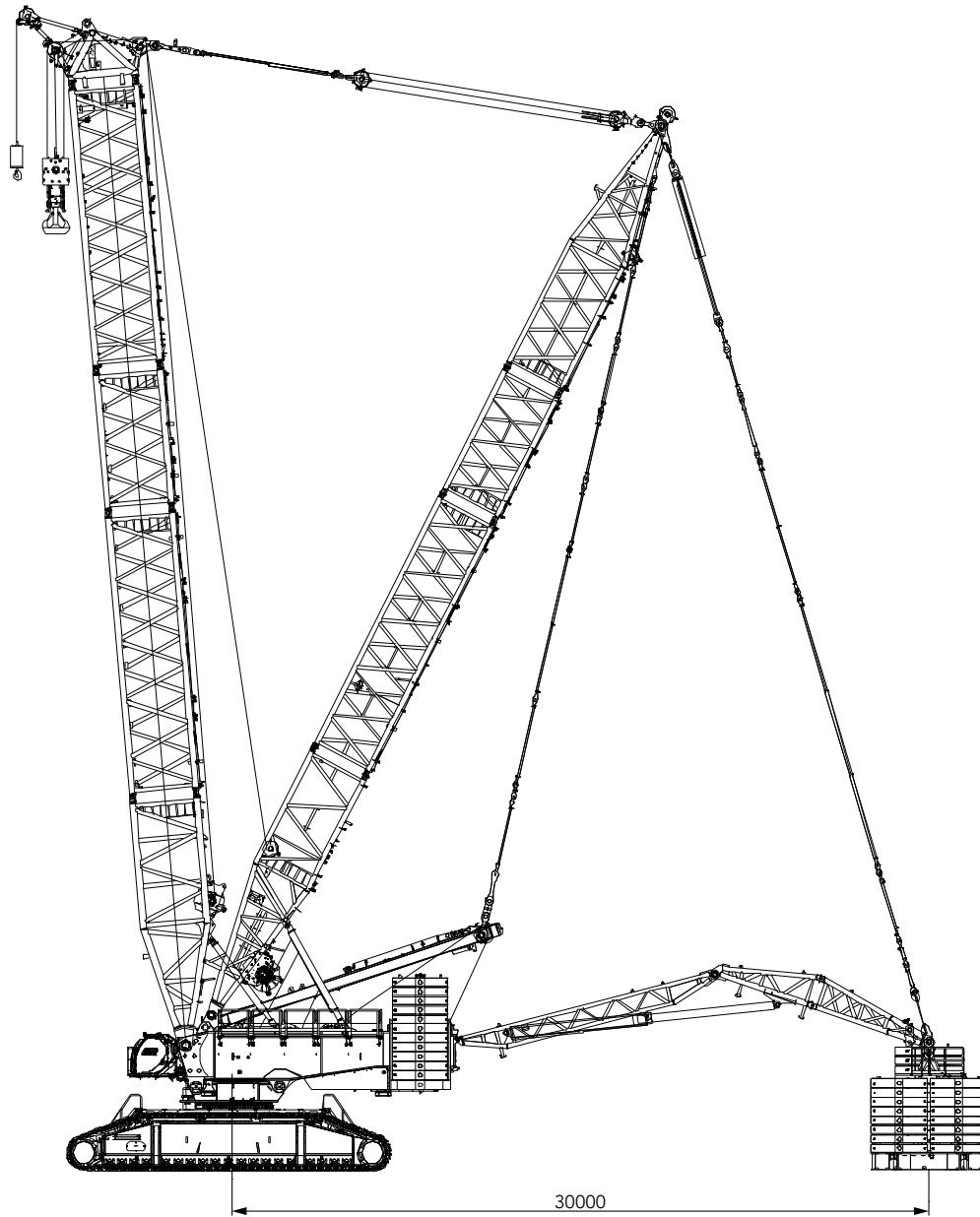

## Transport Dimension

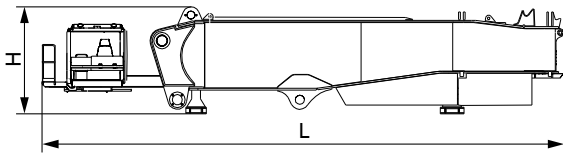

Basic machine (with upper- and lowerworks separated)	×1
Length (L)	15.30m
Width (W)	3.50m
Height (H)	3.15m
Weight	53.6t

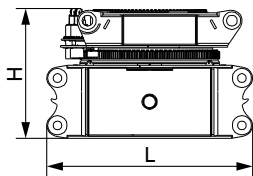

Center slewing structure (carbody+adapter)	×1
Length (L)	5.14m
Width (W)	3.50m
Height (H)	3.24m
Weight	50.0t

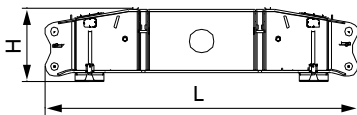

Transverse beam	×2
Length (L)	9.00m
Width (W)	1.81m
Height (H)	2.11m
Weight	21.6t

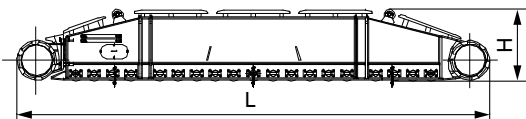

Crawler frame assembly	×2
Length (L)	13.56m
Width (W)	2.07m
Height (H)	2.06m
Weight	43.4t

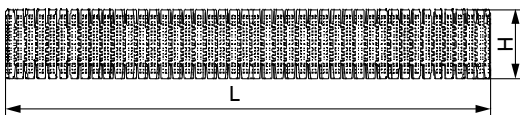

Track pad assembly	×2
Length (L)	13.92m
Width (W)	2.00m
Height (H)	2.38m
Weight	32.1t

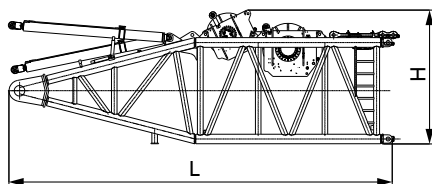

Boom base (H2)(with winch)	×1
Length (L)	10.92m
Width (W)	3.50m
Height (H)	3.20m
Weight	37.0t

Note:aux. load hoist winch 5.4t, jib luffing winch 10.9t.

## Transport Dimension

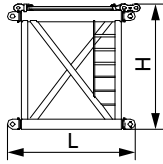

3m transitional insert (H3) ×1	
Length (L)	3.24m
Width (W)	3.50m
Height (H)	3.23m
Weight	4.5t

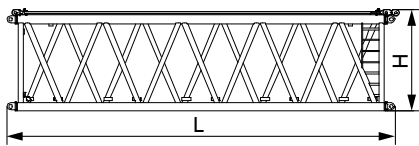

12m transitional insert (H4) ×1	
Length (L)	12.24m
Width (W)	3.50m
Height (H)	3.19m
Weight	14.9t

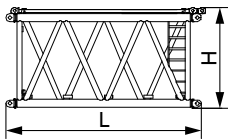

6m boom insert (H6) ×2	
Length (L)	6.24m
Width (W)	3.50m
Height (H)	3.28m
Weight	8.2t

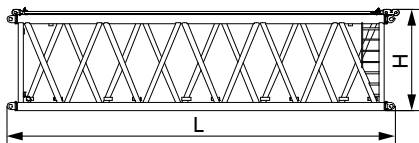

12m boom insert (H8A) ×3	
Length (L)	12.24m
Width (W)	3.50m
Height (H)	3.28m
Weight	15.4t

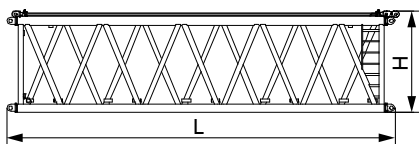

12m boom insert (H8B) ×3	
Length (L)	12.24m
Width (W)	3.50m
Height (H)	3.28m
Weight	15.4t

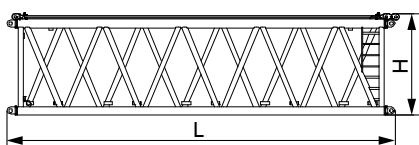

12m boom insert (H8D) ×1	
Length (L)	12.24m
Width (W)	3.50m
Height (H)	3.28m
Weight	11.2t

## Transport Dimension

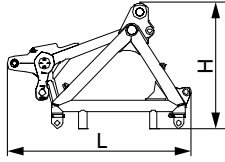

Connecting tip (H9) ×1	
Length (L)	4.17m
Width (W)	3.50m
Height (H)	2.87m
Weight	9.9t

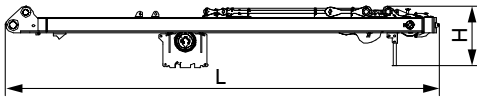

Boom hoist mast ×1	
Length (L)	13.7m
Width (W)	2.87m
Height (H)	1.94m
Weight	28.2t

Note: including boom hoist winch 9.04t.

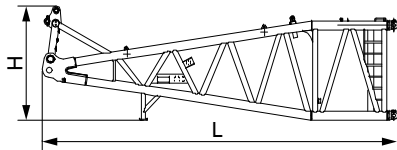

Luffing jib base (LJ2) ×1	
Length (L)	10.83m
Width (W)	3.50m
Height (H)	3.47m
Weight	13.5t

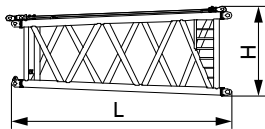

6m jib tapered insert (LJ4) ×1	
Length (L)	6.24m
Width (W)	3.50m
Height (H)	3.21m
Weight	5.8t

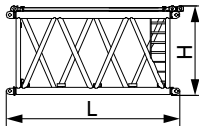

Luffing jib insert (LJ6) ×2	
Length (L)	6.23m
Width (W)	3.00m
Height (H)	2.57m
Weight	5.13t

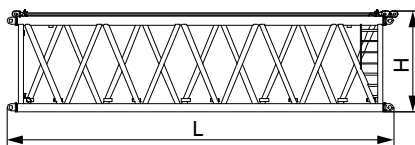

Luffing jib insert (LJ8A) ×2	
Length (L)	12.23m
Width (W)	3.00m
Height (H)	2.57m
Weight	8.33t



## Transport Dimension

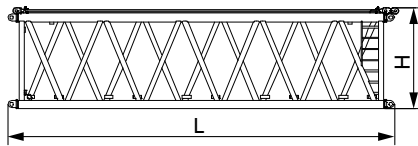

Luffing jib insert (LJ8B)	×4
Length (L)	12.23m
Width (W)	3.00m
Height (H)	2.57m
Weight	7.58t

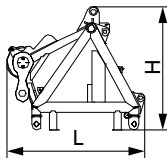

Jib tip (LJ9)	×1
Length (L)	3.04m
Width (W)	3.04m
Height (H)	2.74m
Weight	5.51t

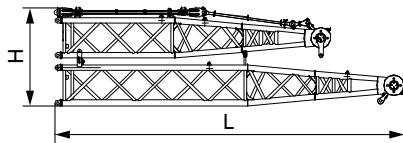

Rear and front mast top of luffing jib	×1
Length (L)	11.94m
Width (W)	2.98m
Height (H)	3.34m
Weight	13.0t

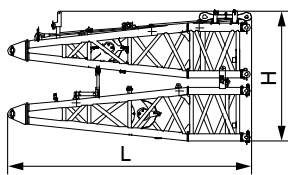

Rear and front mast base of luffing jib	×1
Length (L)	6.25m
Width (W)	2.89m
Height (H)	3.34m
Weight	7.3t

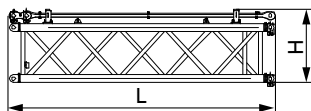

6m front mast of luffing jib	×1
Length (L)	6.24m
Width (W)	2.97m
Height (H)	1.71m
Weight	2.88t

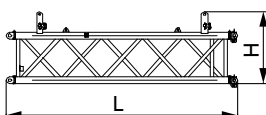

6m rear mast of luffing jib	×1
Length (L)	6.18m
Width (W)	2.13m
Height (H)	1.94m
Weight	2.21t

## Transport Dimension

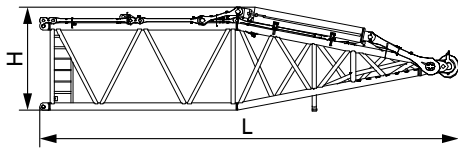

### Superlift mast top (D1) ×1

Length (L)	13.02m
Width (W)	3.45m
Height (H)	3.20m
Weight	20.2t

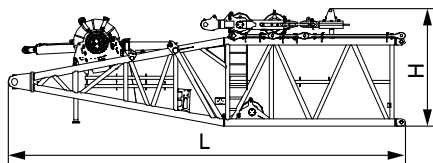

### Superlift mast base (D2)(with winch) ×1

Length (L)	12.32m
Width (W)	3.50m
Height (H)	3.64m
Weight	36.3t

Note: superlift luffing winch 12.65t.

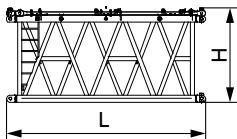

### 6m superlift mast insert (D4) ×1

Length (L)	6.24m
Width (W)	3.49m
Height (H)	2.89m
Weight	6.23t

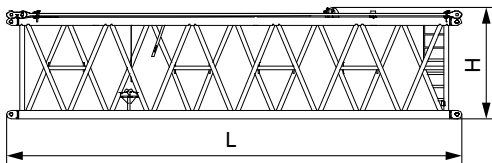

### 12m superlift mast insert(D6) ×1

Length (L)	12.24m
Width (W)	3.49m
Height (H)	2.89m
Weight	11.37t

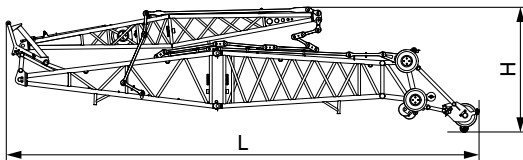

### Fixed jib ×1

Length (L)	14.35m
Width (W)	2.33m
Height (H)	3.78m
Weight	10.25t

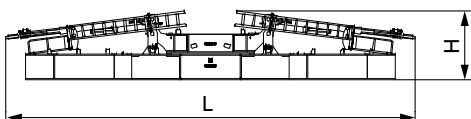

### Superlift counterweight frame ×1

Length (L)	11.21m
Width (W)	3.00m
Height (H)	1.87m
Weight	32.0t

## Transport Dimension

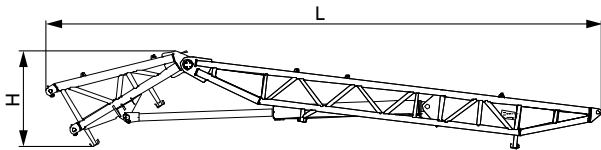

**Superlift strut stage 1 and 2 (including cylinder) ×1**

Length (L)	16.00m
Width (W)	3.50m
Height (H)	2.40m
Weight	17.3t

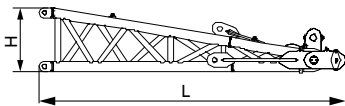

**Superlift strut stage 3 ×1**

Length (L)	6.27m
Width (W)	3.45m
Height (H)	1.52m
Weight	5.6t

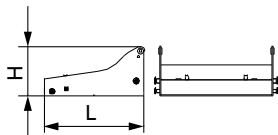

**Carbody counterweight tray ×2**

Length (L)	2.98m
Width (W)	3.67m
Height (H)	1.47m
Weight	15.0t

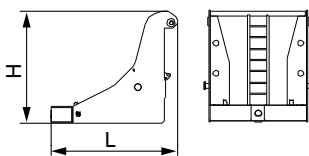

**Rear counterweight tray ×2**

Length (L)	3.35m
Width (W)	2.86m
Height (H)	2.96m
Weight	15.0t

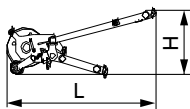

**Boom extension jib ×1**

Length (L)	2.65m
Width (W)	1.27m
Height (H)	1.41m
Weight	0.58t

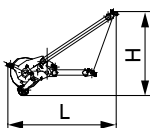

**Luffing jib extension jib ×1**

Length (L)	2.44m
Width (W)	1.13m
Height (H)	1.90m
Weight	0.58t

## Transport Dimension

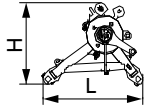

Pulley block (650t) ×2	
Length (L)	1.85m
Width (W)	1.67m
Height (H)	1.51m
Weight	2.1t

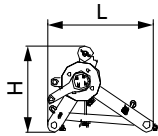

Pulley block (1250t) ×2	
Length (L)	1.85m
Width (W)	2.09m
Height (H)	1.94m
Weight	3.7t

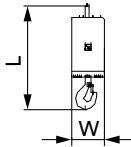

25t hook ×1	
Length (L)	1.64m
Width (W)	0.54m
Height (H)	0.54m
Weight	1.7t

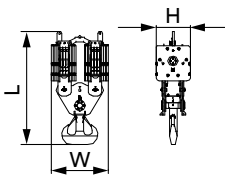

250t hook ×1	
Length (L)	3.66m
Width (W)	1.83m
Height (H)	1.10m
Weight	11.9t

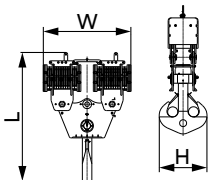

800t hook ×1	
Length (L)	5.06m
Width (W)	3.45m
Height (H)	1.89m
Weight	22.3t

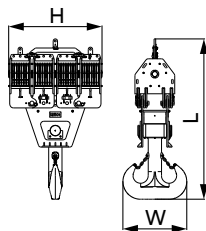

1250t hook ×1	
Length (L)	6.02m
Width (W)	3.51m
Height (H)	2.40m
Weight	30.6t

## Transport Dimension

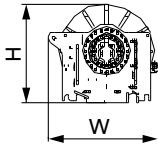

Main load hoist winch		×2
Length (L)	2.15m	
Width (W)	1.68m	
Height (H)	1.50m	
Weight	12.7t	

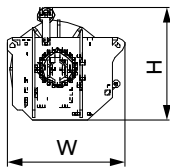

Aux. load hoist winch		×1
Length (L)	2.06m	
Width (W)	1.50m	
Height (H)	1.44m	
Weight	5.4t	

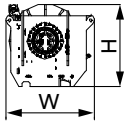

Jib luffing winch		×1
Length (L)	2.06m	
Width (W)	1.76m	
Height (H)	1.63m	
Weight	10.9t	

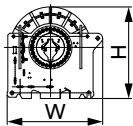

Boom hoist winch		×1
Length (L)	2.48m	
Width (W)	1.56m	
Height (H)	1.49m	
Weight	9.04t	

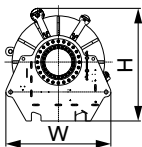

Superlift luffing winch		×1
Length (L)	2.15m	
Width (W)	1.64m	
Height (H)	1.75m	
Weight	12.65t	

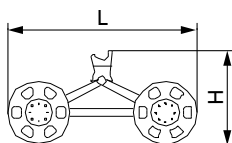

Trolley		×1
Length (L)	3.10m	
Width (W)	2.14m	
Height (H)	1.40m	
Weight	1.8t	

## Transport Dimension

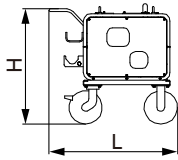

Portable power pack		x1
Length (L)		1.80m
Width (W)		1.20m
Height (H)		1.40m
Weight		0.6t

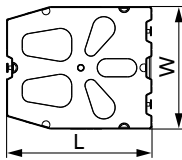

10t counterweight block		x79
Length (L)		2.85m
Width (W)		2.40m
Height (H)		0.45m
Weight		10.0t

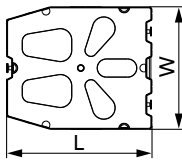

5t counterweight block		x2
Length (L)		2.85m
Width (W)		2.40m
Height (H)		0.26m
Weight		5.0t

Note:

- 1.The transport dimensions of each part are schematic, may not be proportional to the real parts. The dimensions are designed value without package considered.
- 2.The weight is designed value that the actual manufactured part may deviate slightly.
- 3.The dimensions and weight of each part may upgrade along the time. The final values are subject to the new product.



## Assembly Procedure

### Boom assembly

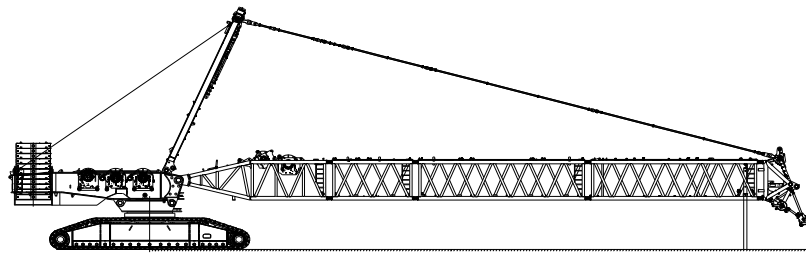
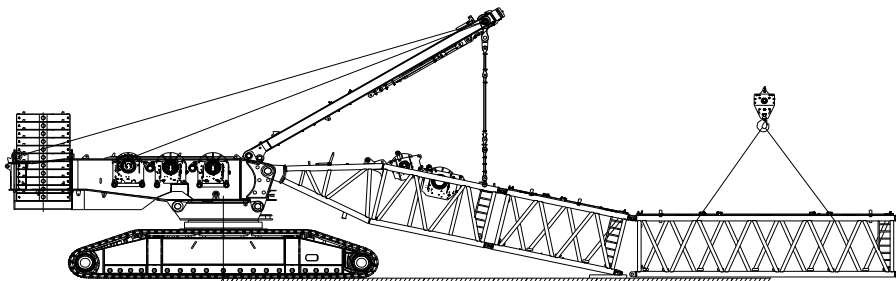
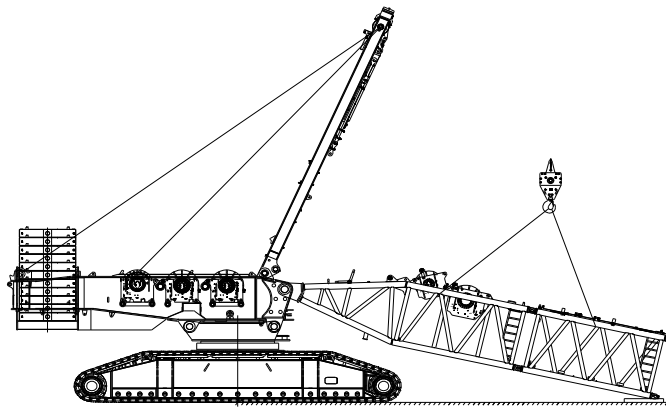
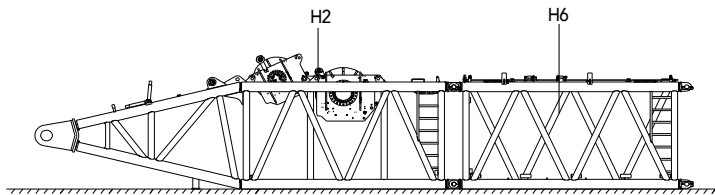



# **SCE12500A SANY CRAWLER CRANE**

QUALITY CHANGES THE WORLD

## Configurations

- Page 25 Configurations Combination
- Page 27 H Configuration
- Page 30 HDB Configuration
- Page 33 HJ Configuration
- Page 36 HJDB Configuration
- page 39 LJ Configuration
- page 43 LJDB Configuration
- page 56 HJFJDB Configuration

## Combination

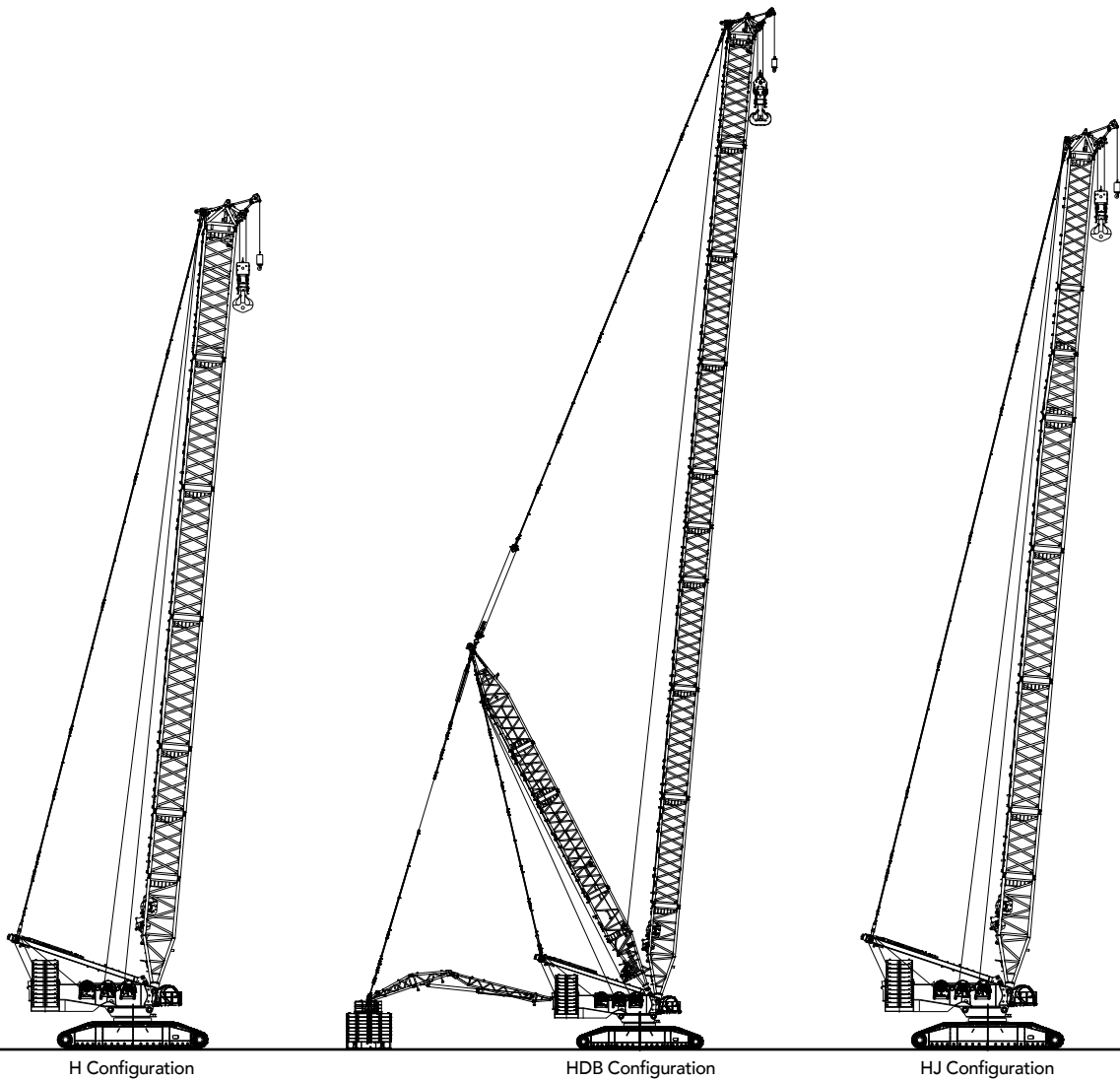

Configuration	Boom combination	Boom length
H	Boom	30m~72m
HDB	Boom + Superlift mast + Superlift counterweight	42m~108m
HJ	Mixed boom	48m~78m

Note: The schematics above are reference for loading only.

## Combination

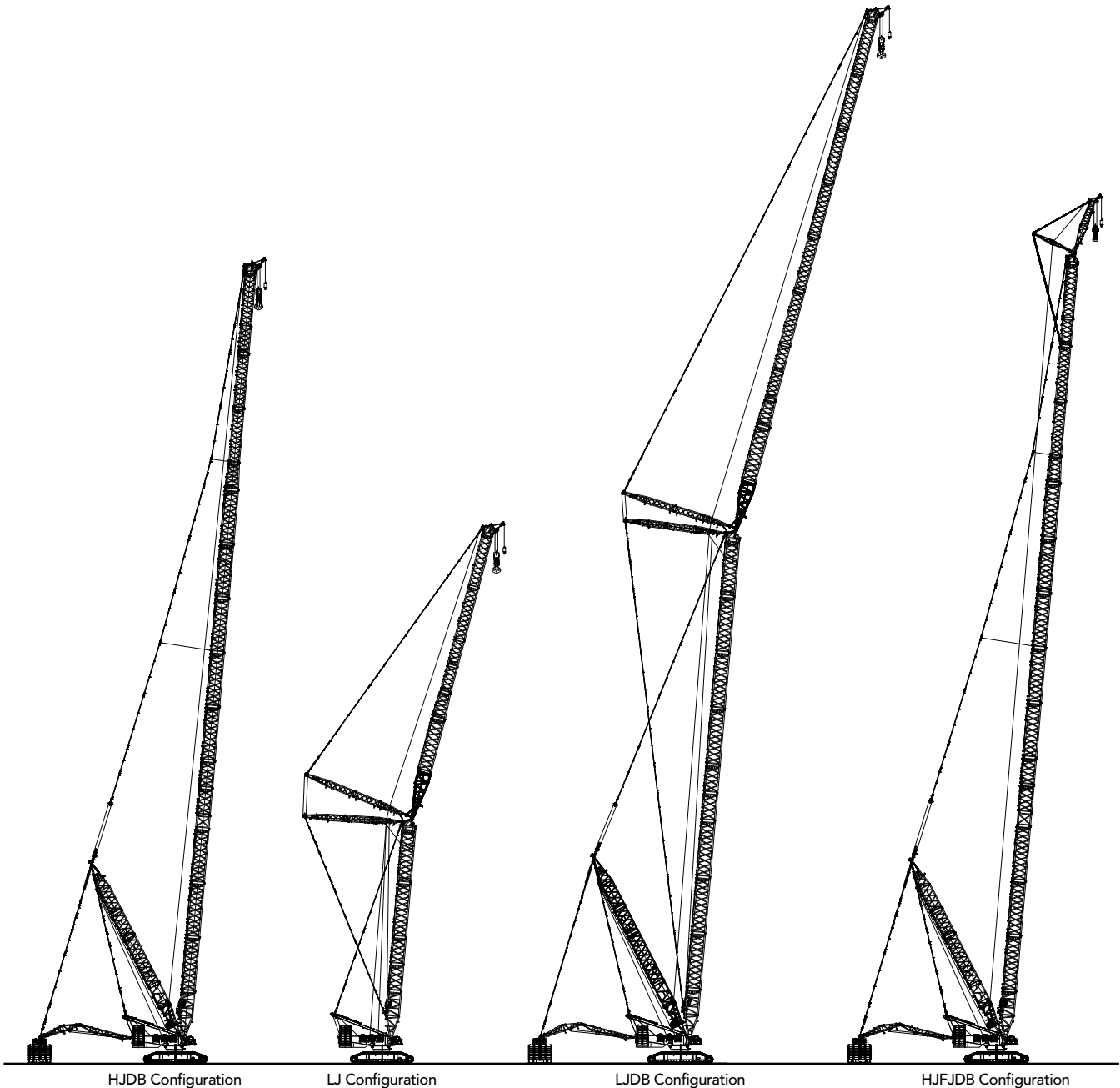

Configuration	Boom combination	Boom length
HJDB	Mixed boom + Superlift mast + Superlift counterweight	84m~171m
LJ	Boom + Luffing jib	(42m~48m) + (36m~66m)
LJDB	Boom + Luffing jib + Superlift mast + Superlift counterweight	(48m~108m) + (30m~114m)
HJFJDB	mixed boom + Fixed jib + Superlift mast + Superlift counterweight	(102m~171m) +12m

Note: The schematics above are reference for loading only.

## Combination of H Configuration

Combination of H configuration					
Boom length (m)	Boom				
	H2	H6	H8A	H4	H9
30	1	1	-	1	1
36	1	2	-	1	1
42	1	1	1	1	1
48	1	2	1	1	1
54	1	1	2	1	1
60	1	2	2	1	1
66	1	1	3	1	1
72	1	2	3	1	1

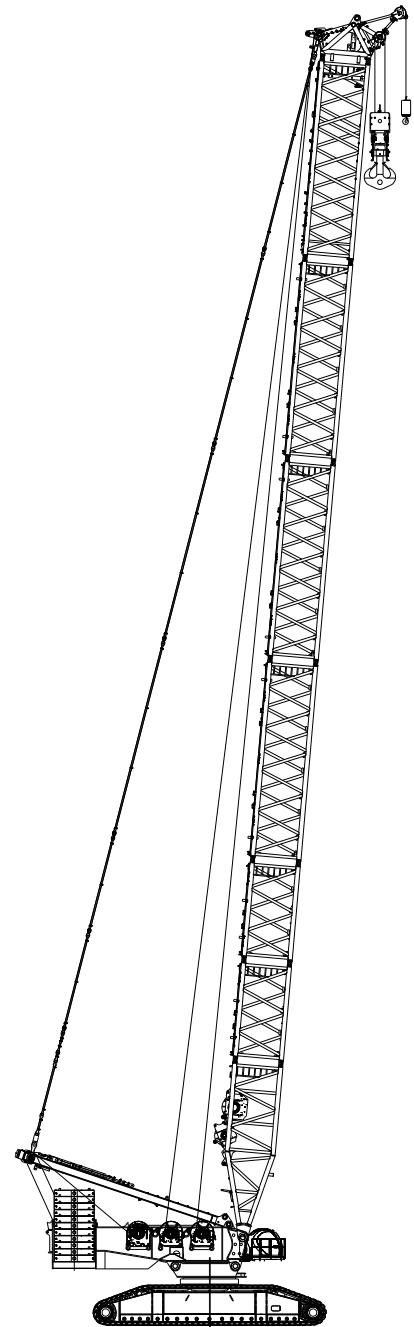

H Configuration  
(30m~72m)

## Working Range of H

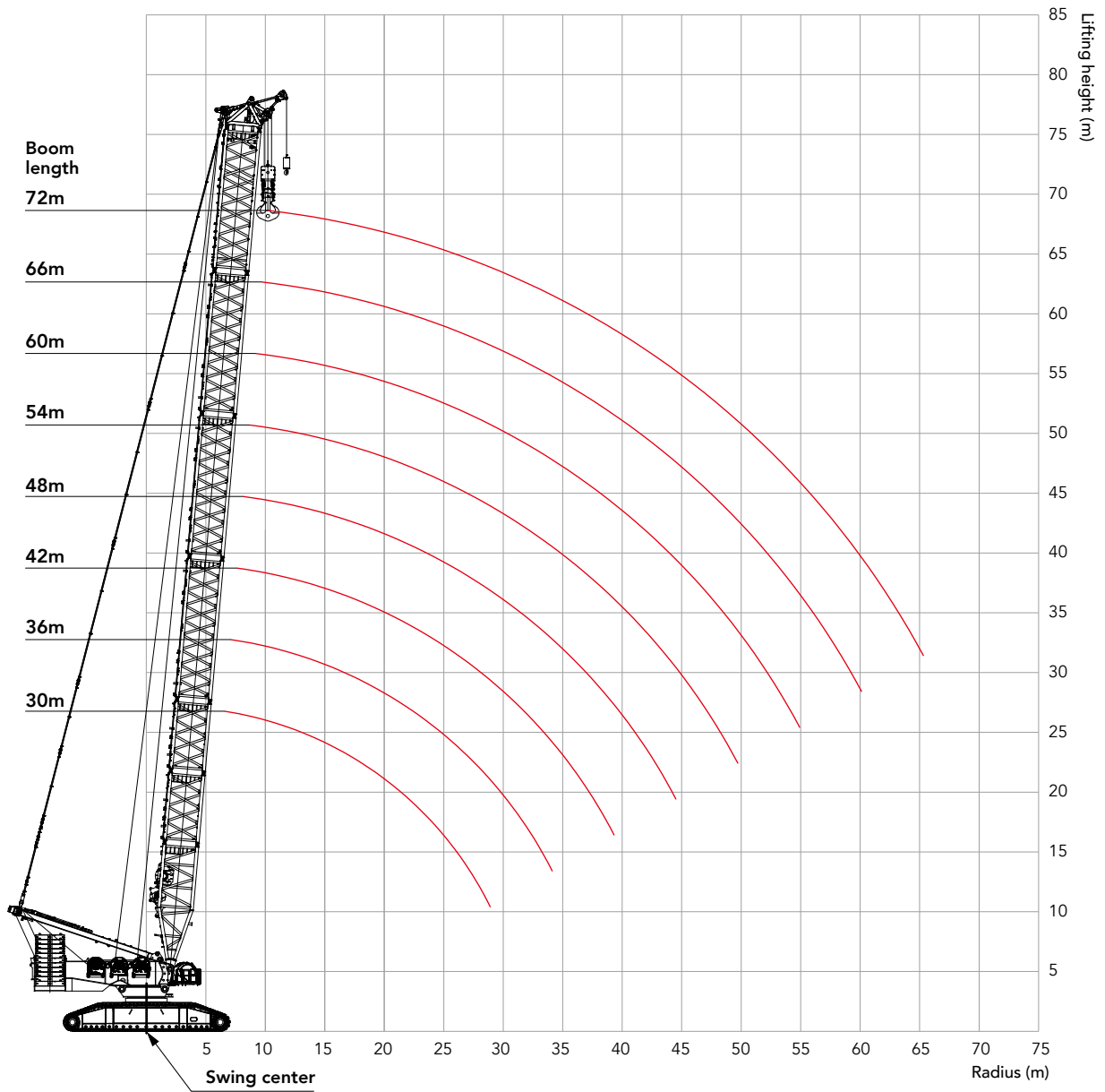



## Load Chart of H Configuration

Note:

1. Meet the ISO4305 standard;
2. The superlift counterweight cannot leave the ground in the configurations marked with \*;
3. The actual lifting capacity must subtract the weight of hooks, wire rope and other riggings from the rated capacity in the load chart.

Load chart -H									
Boom Length 30~72m, Rear Counterweight 250t, Carbody Counterweight 90t									
BL/R (m)	30	36	42	48	54	60	66	72	BL/R (m)
7	844								7
7.5	775	773							7.5
8	716	715	713						8
9	621	619	618	615	613				9
10	548	546	544	542	539	537	535		10
11	489	487	485	483	480	478	476	473	11
12	441	439	437	435	432	430	427	425	12
13	402	399	397	395	392	390	387	385	13
14	368	366	364	361	359	356	353	351	14
15	339	337	335	332	330	327	325	322	15
16	314	312	310	307	305	302	300	297	16
17	293	290	288	286	283	280	278	275	17
18	273	271	269	266	264	261	258	255	18
19	256	254	252	249	247	244	241	238	19
20	241	239	237	234	232	229	226	223	20
22	215	213	211	208	205	202	200	197	22
24	193	191	189	186	184	181	178	175	24
26	175	173	171	168	166	163	160	157	26
28	159	158	155	153	150	147	144	141	28
30		144	142	140	137	134	131	128	30
32		133	131	128	126	123	120	117	32
34		122	121	118	115	112	110	106	34
36			112	109	106	103	101	98	36
38			103	101	98.9	95.9	93.1	90	38
40				94.1	91.7	88.7	85.9	82.8	40
44				81.4	79.1	76.3	73.5	70.4	44
48					68.6	65.8	63.1	60	48
52						57	54.3	51.2	52
56							46.7	43.7	56
60							40	37.1	60
64								31.3	64

## Combination of HDB Configuration

Combination of HDB configuration						
Boom length (m)	Boom					
	H2	H6	H8A	H8B	H4	H9
42	1	1	1	-	1	1
48	1	2	1	-	1	1
54	1	1	2	-	1	1
60	1	2	2	-	1	1
66	1	1	3	-	1	1
72	1	2	3	-	1	1
78	1	1	3	1	1	1
84	1	2	3	1	1	1
90	1	1	3	2	1	1
96	1	2	3	2	1	1
102	1	1	3	3	1	1
108	1	2	3	3	1	1

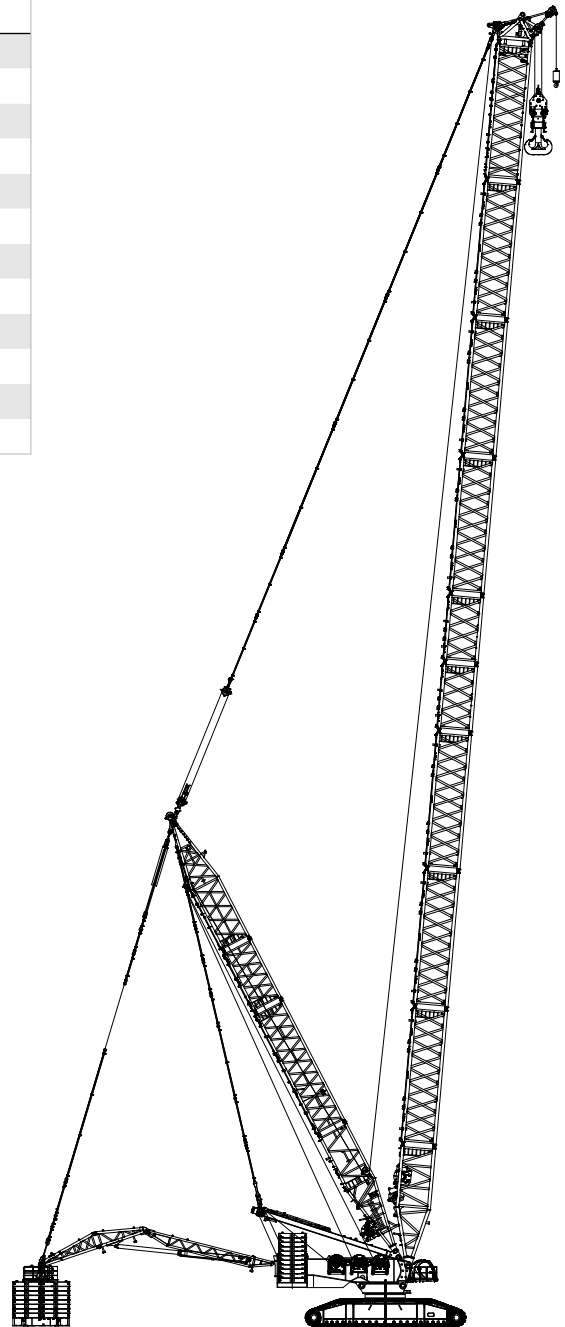

HDB Configuration  
(42m~108m)

## Working Range of HDB

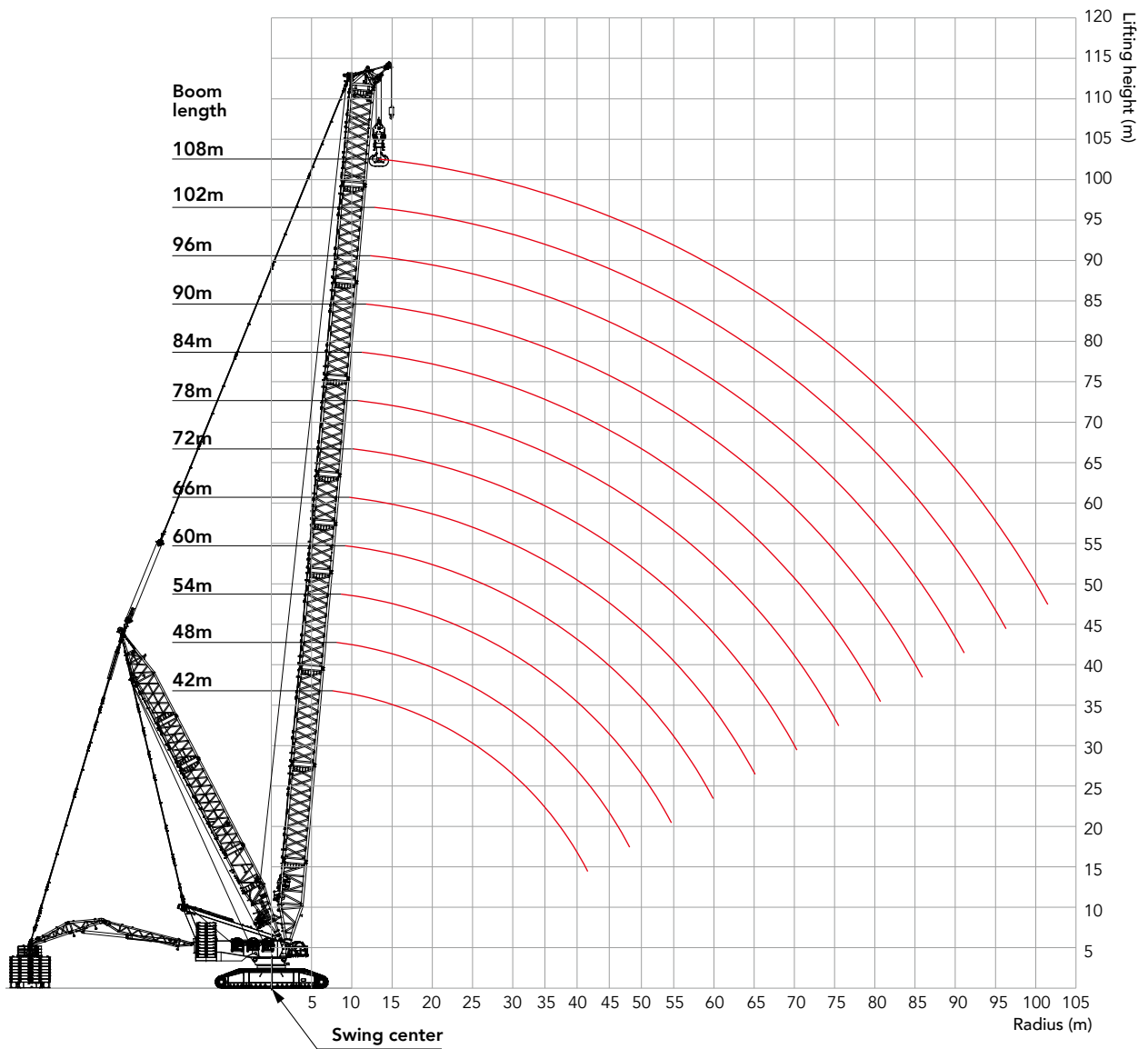

## Load Chart of HDB Configuration

### Note:

1. Meet the requirements of ISO4305.
2. The data with the asterisk mark (\*) in the table means that the superlift counterweight in this configuration is not off the ground.
3. The rated load in the table includes the weight of the hook, wire rope and other lifting tools. To obtain the weight can be lifted, use the rated load in the table to minus the weights of hooks, wire ropes and other lifting tools.

### Load chart -HDB

Boom 42m~108m, Superlift Radius 30m, Superlift Counterweight 550t, Rear Counterweight 250t, Carbody Counterweight 90t

BL/R (m)	42	48	54	60	66	72	78	84	90	96	102	108	BL/R (m)
8	1250*												8
9	1250*	1250*	1250*										9
10	1250*	1250*	1250*	1140*	1060*								10
11	1250*	1250*	1250*	1140*	1060*	940*	899*						11
12	1250*	1250*	1250*	1140*	1060*	940*	899*	818*	777*				12
13	1250*	1250*	1250*	1140*	1060*	980*	899*	818*	777*	694*	609*		13
14	1250*	1250*	1250*	1140*	1060*	980*	899*	818*	777*	694*	610*	542*	14
15	1250*	1250*	1250*	1179*	1060*	980*	899*	818*	777*	699*	611*	542*	15
16	1225*	1222*	1220*	1179*	1060*	980*	899*	818*	777*	700*	612*	542*	16
17	1154*	1151*	1149*	1146*	1060*	980*	899*	818*	777*	700*	614*	544*	17
18	1091	1087*	1085*	1083*	1060*	980*	899*	818*	777*	700*	616*	546*	18
19	1033*	1030	1028	1025	1022	980*	899*	818*	777*	702*	615*	546*	19
20	982*	978	976	974	970	968	899*	818*	777*	704*	615*	546*	20
22	892	889	887	884	881	878	876	818*	777*	704*	618*	548*	22
24	817	814	812	809	806	803	801	798	777	706*	617*	550*	24
26	753	750	748	745	742	739	737	734	731	709	619*	548*	26
28	697	694	692	689	686	684	682	679	676	673	620*	549*	28
30	646	643	641	638	635	633	631	628	626	623	614	550*	30
32	601	598	596	594	591	588	586	583	581	578	576	551	32
34	562	559	557	555	552	549	547	544	542	539	537	527	34
36	528	525	523	520	517	515	513	510	508	505	502	499	36
38	488	494	492	489	486	484	482	479	477	474	471	468	38
40		466	464	462	459	456	454	451	449	446	444	441	40
44		419	417	414	411	408	407	404	401	398	396	393	44
48			377	374	372	369	367	364	362	359	357	354	48
52				341	338	336	334	331	329	326	323	320	52
56					310	307	305	302	300	297	295	292	56
60					285	282	280	278	275	272	270	267	60
64						261	259	256	254	251	249	245	64
68							240	237	235	232	230	226	68
72								220	218	215	213	210	72
76									203	200	198	194	76
80									189	186	184	181	80
84										174	172	169	84
88											160	157	88
92												147	92
96												138	96

## Combination of HJ Configuration

Combination of HJ configuration							
Boom length (m)	Boom						
	H2	H6	H8A	LJ4	LJ6	LJ8A	LJ9
48	1	-	1	1	1	1	1
54	1	1	1	1	1	1	1
60	1	2	1	1	1	1	1
66	1	1	2	1	1	1	1
72	1	2	2	1	1	1	1
78	1	1	3	1	1	1	1

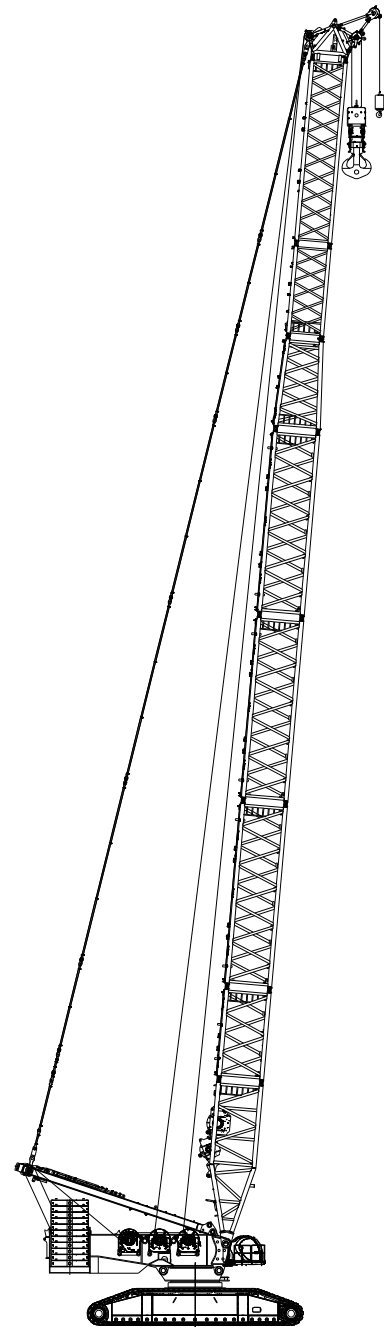

HJ Configuration  
(48m~78m)

### Working Range of HJ

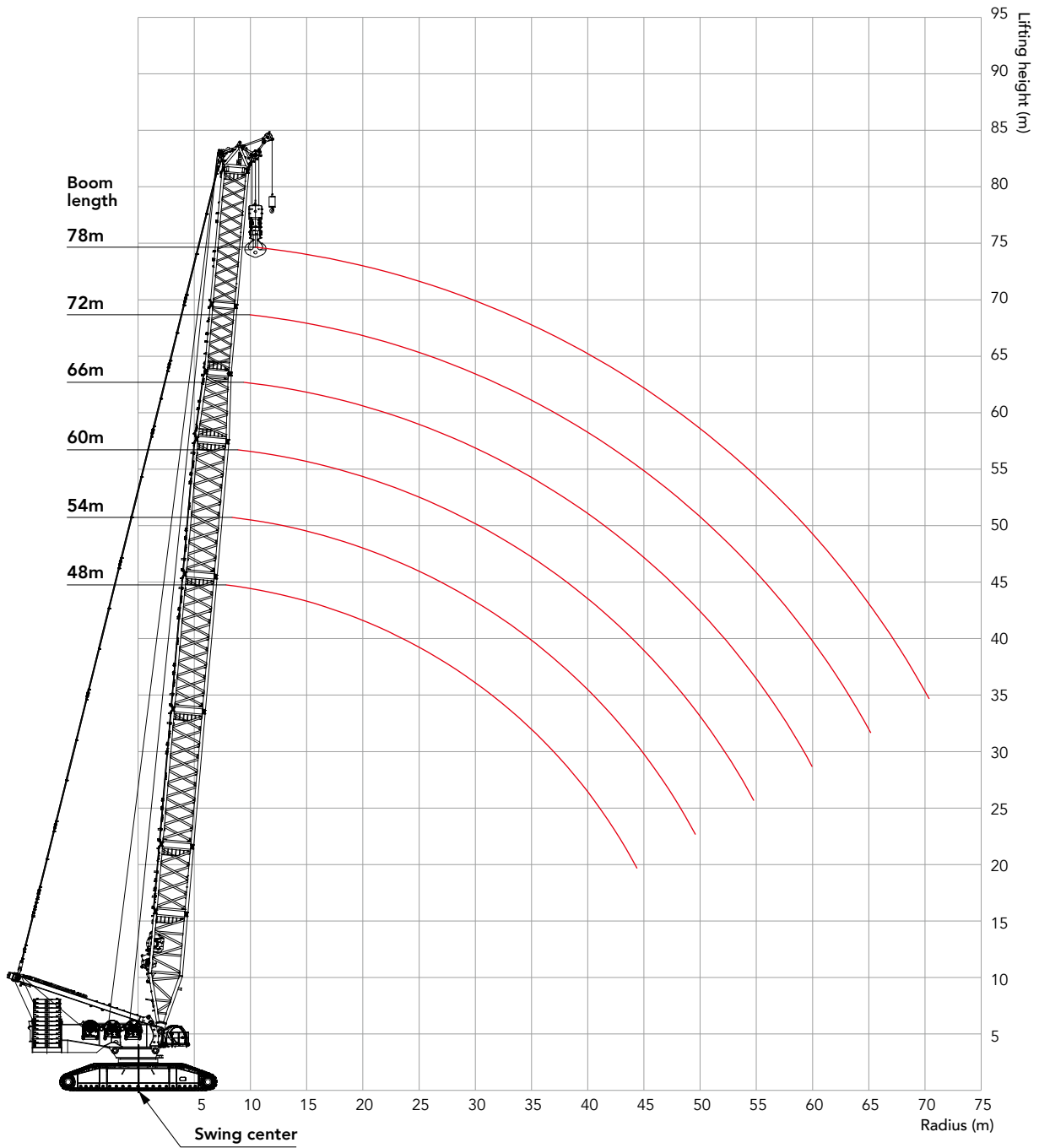

## Load Chart of HJ Configuration

Load chart -HJ							
Boom Length 48~78m, Rear Counterweight 250t, Carbody Counterweight 90t							
BL/R (m)	48	54	60	66	72	78	BL/R (m)
8	650						8
9	624	621	619				9
10	550	548	545	543	541		10
11	492	489	487	484	482	479	11
12	444	442	439	437	434	431	12
13	404	402	399	397	394	392	13
14	371	368	366	363	361	358	14
15	342	340	337	335	332	329	15
16	317	315	312	310	307	304	16
17	296	293	290	288	285	282	17
18	277	274	271	269	266	263	18
19	260	257	254	252	249	246	19
20	245	242	239	237	234	231	20
22	219	216	213	211	208	205	22
24	197	194	192	189	186	183	24
26	179	176	174	171	168	165	26
28	164	161	158	156	153	150	28
30	151	148	145	142	139	137	30
32	139	137	134	131	128	125	32
34	129	127	124	121	118	115	34
36	120	118	115	112	109	106	36
38	112	110	107	104	101	98.8	38
40	105	103	100	97.6	94.6	91.7	40
44	93	90.7	88	85.3	82.3	79.3	44
48		80.2	77.6	75	72	69.1	48
52			68.8	66.2	63.3	60.4	52
56				58.7	55.8	53	56
60					49.3	46.5	60
64					43.6	40.8	64
68						35.7	68

## Combination of HJDB Configuration

Combination of HJDB configuration												
Boom length (m)	Boom						Jib					
	H2	H3	H6	H8A	H8B	H4	H8D	LJ4	LJ6	LJ8A	LJ8B	LJ9
84	1	-	1	3	1	1	-	1	-	-	-	1
90	1	-	2	3	1	1	-	1	-	-	-	1
96	1	-	1	3	2	1	-	1	-	-	-	1
102	1	-	2	3	2	1	-	1	-	-	-	1
108	1	-	1	3	3	1	-	1	-	-	-	1
114	1	-	2	3	3	1	-	1	-	-	-	1
120	1	-	1	3	3	1	1	1	-	-	-	1
126	1	-	2	3	3	1	1	1	-	-	-	1
132	1	-	2	3	3	1	1	1	1	-	-	1
138	1	-	2	3	3	1	1	1	-	1	-	1
144	1	-	2	3	3	1	1	1	1	1	-	1
150	1	-	2	3	3	1	1	1	2	1	-	1
156	1	-	2	3	3	1	1	1	1	2	-	1
162	1	-	2	3	3	1	1	1	2	2	-	1
165	1	1	2	3	3	1	1	1	2	2	-	1
168	1	-	2	3	3	1	1	1	1	2	1	1
171	1	1	2	3	3	1	1	1	1	2	1	1

Note: For boom length of 138m~171m, the mid-point suspension cable must be used, otherwise, the boom system may break.

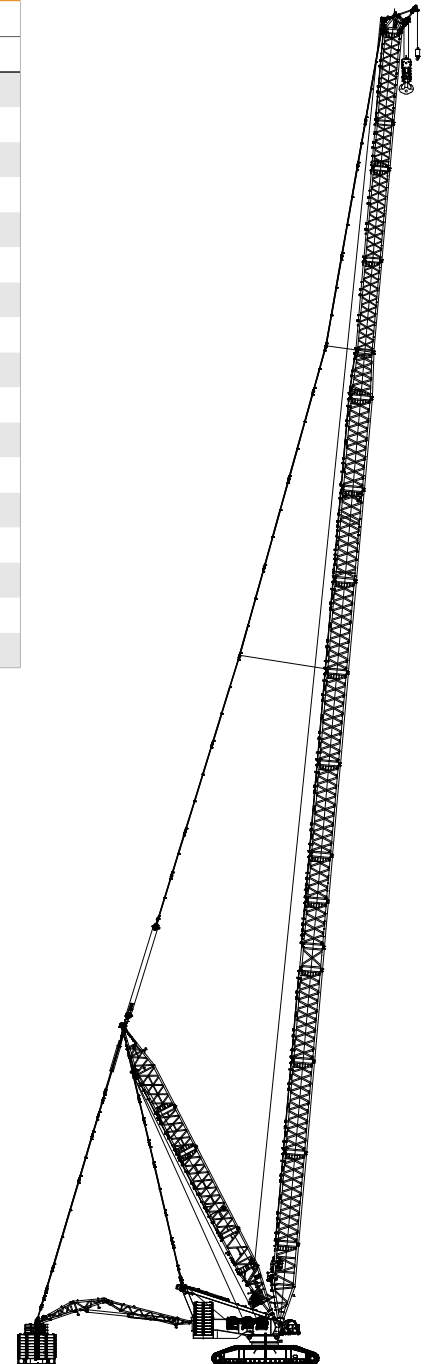

HJDB Configuration  
(84m~171m)



## Working Range of HJDB

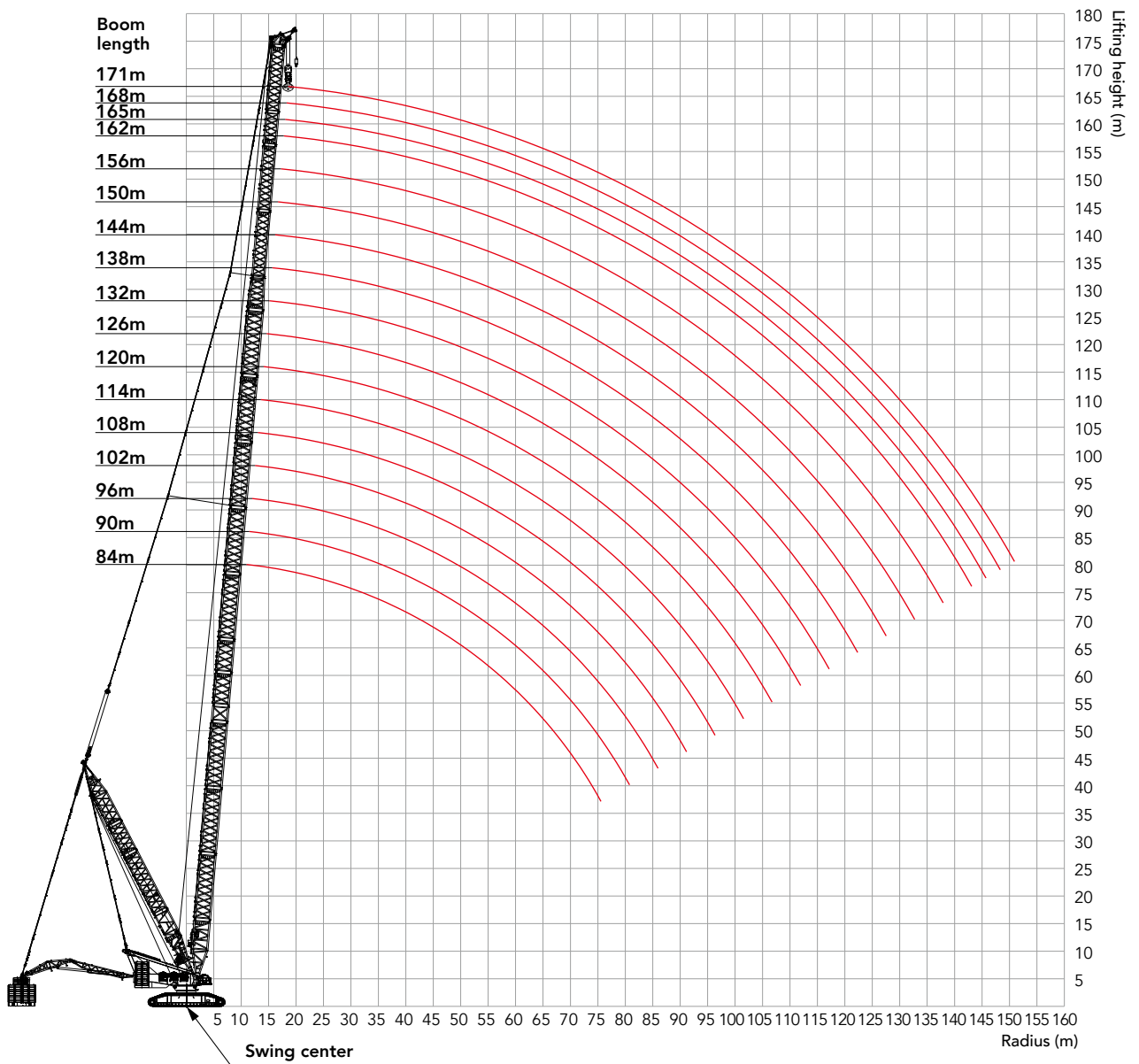

## Load Chart of HJDB Configuration

### Note:

1. Meet the requirements of ISO4305.
2. The data with the asterisk mark (\*) in the table means that the superlift counterweight in this configuration is not off the ground.
3. The rated load in the table includes the weight of the hook, wire rope and other lifting tools. To obtain the weight can be lifted, use the rated load in the table to minus the weights of hooks, wire ropes and other lifting tools.

### Load chart -HJDB

Boom Length 84~171m, Superlift Radius 30m, Superlift Counterweight 550t, Rear Counterweight 250t, Carbody Counterweight 90t

BL/R(m)	84	90	96	102	108	114	120	126	132	138	144	150	156	162	165	168	171	BL/R(m)
12	650*	650*																12
13	650*	650*	650*	621*														13
14	650*	650*	650*	622*	547*	489*												14
15	650*	650*	650*	623*	548*	489*	434*	390*										15
16	650*	650*	650*	623*	548*	489*	434*	390*	351*	315*								16
17	650*	650*	650*	623*	550*	491*	435*	392*	351*	315*	284*							17
18	650*	650*	650*	624*	551*	492*	436*	393*	351*	315*	285*	254*	229*					18
19	650*	650*	650*	625*	551*	492*	435*	393*	352*	316*	284*	255*	229*	203*	195*	181*	173*	19
20	650*	650*	650*	627*	551*	492*	435*	393*	353*	316*	284*	255*	229*	203*	194*	180*	172*	20
22	650*	650*	650*	626*	553*	493*	436*	392*	352*	318*	285*	256*	230*	202*	193*	179*	171*	22
24	650*	650*	650*	628*	555*	495*	437*	392*	354*	317*	286*	256*	230*	201*	192*	178*	170*	24
26	650*	650*	650*	630*	553*	493*	436*	394*	353*	318*	287*	257*	229*	200*	191*	177*	169*	26
28	650	650	650	632*	555*	494*	437*	395*	354*	319*	283*	253*	226*	199*	190*	176*	168*	28
30	630	627	625	616	555*	495*	438*	395*	351*	316*	283*	253*	226*	198*	189*	174*	167*	30
32	586	583	580	577	556	495*	438*	393*	352*	317*	282*	253*	225*	197*	188*	173*	166*	32
34	547	544	541	538	529	495*	438*	394*	351*	316*	282*	253*	224*	195*	187*	172*	165*	34
36	512	509	507	504	501	486	438*	395*	352*	316*	283*	253*	223*	194*	186*	170*	164*	36
38	481	478	476	473	471	467	438	393*	352*	316*	283*	251*	221*	193*	184*	169*	162*	38
40	453	451	448	445	443	440	428	394*	353*	317*	282*	250*	220*	191*	183*	168*	161*	40
44	406	403	401	398	395	392	392	389	351*	315*	282*	247*	217*	188*	180*	165*	159*	44
48	366	363	361	358	356	353	353	349	348	315*	279*	244*	214*	185*	178*	162*	156*	48
52	333	330	328	325	322	319	319	316	315	313	275*	241*	211*	183*	175*	159*	153*	52
56	305	302	299	296	294	291	291	288	286	287	272	238*	208*	179*	172*	156*	151*	56
60	280	277	275	272	269	266	266	263	262	262	261	235*	205*	176*	170*	153*	148*	60
64	258	255	253	250	248	245	245	241	240	240	239	231	201*	173*	167*	150*	145*	64
68	239	236	234	231	229	226	226	222	221	221	220	219	198	170*	164*	148*	143*	68
72	222	219	217	214	212	209	209	206	204	205	203	202	195	167*	162*	145*	140*	72
76		204	202	199	197	194	194	191	189	190	188	187	187	164*	159*	142*	137*	76
80		191	188	185	183	180	180	177	176	176	175	173	173	161	156	139*	135*	80
84			176	173	171	168	168	165	164	164	162	161	161	158	153	137*	132*	84
88				162	160	157	157	154	152	153	151	150	150	148	146	134	130	88
92					149	146	147	143	142	143	141	140	140	138	136	131	127	92
96					140	137	137	134	133	133	132	130	130	129	127	129	125	96
100						128	129	125	124	125	123	122	122	120	118	121	119	100
104							121	117	116	117	115	114	114	112	111	113	111	104
108								110	109	109	108	107	107	105	103	105	104	108
112								103	102	102	101	100	100	98.6	96.9	99	97.2	112
116									96.2	96.5	95.3	93.9	93.8	92.3	90.6	92.6	90.9	116
120										90.5	89.3	88	87.9	86.3	84.6	86.7	85	120
124											83.7	82.4	82.3	80.8	79.1	81.2	79.5	124
128												77.1	77.1	75.6	73.9	75.9	74.3	128
132													72.2	72.1	70.6	69	69.4	132
136														67.5	66	64.3	66.4	136
140															61.6	59.9	62	140
144																55.8	57.9	144
148																	54	148

## Combination of LJ Configuration

Combination of LJ configuration					
Boom length (m)	Boom				
	H2	H6	H8A	H4	H9
42	1	1	1	1	1
48	1	2	1	1	1

Combination of LJ configuration						
Boom length (m)	Jib					
	LJ2	H8D	LJ4	LJ6	LJ8A	LJ9
36	1	1	1	1	-	1
42	1	1	1	-	1	1
48	1	1	1	1	1	1
54	1	1	1	-	2	1
60	1	1	1	1	2	1
66	1	1	1	2	2	1

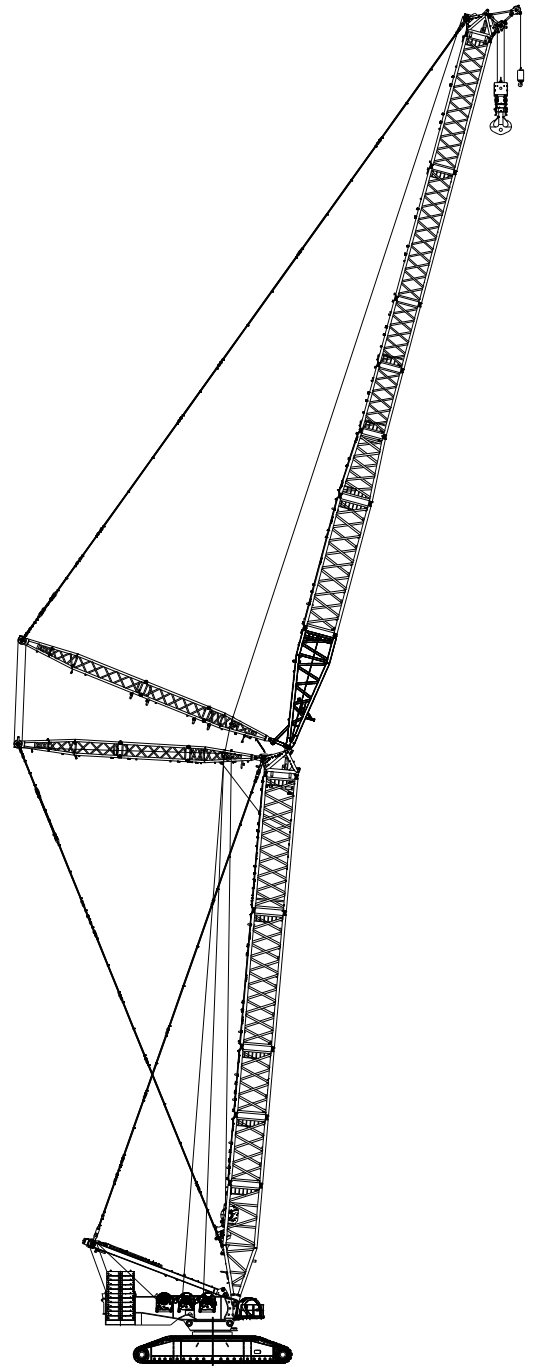

LJ Configuration  
(42m~48m) + (36m~66m)

## Working Range of LJ

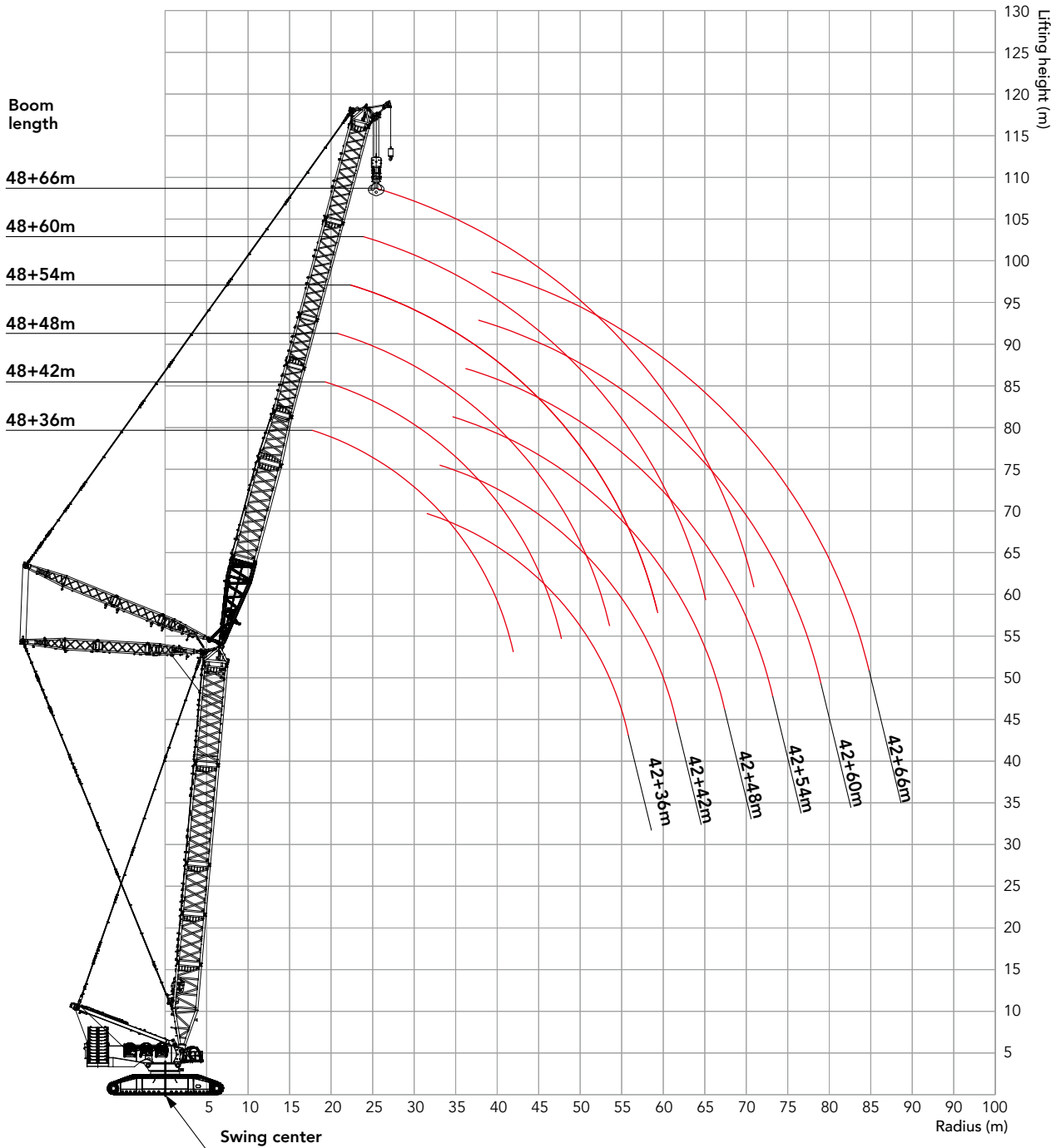

## Load Chart of LJ Configuration

Load chart -LJ 1/2							
Boom Length 42m, Boom Angle 85°, Jib Length36~66m, Rear counterweight 250t, Carbody counterweight 90t							
BL/R (m)	36	42	48	54	60	66	BL/R (m)
18	281						18
19	264	263					19
20	248	248					20
22	222	221	219				22
24	201	200	198	197	194		24
26	182	182	180	179	177	175	26
28	167	166	164	163	161	161	28
30	153	153	151	150	148	147	30
32	142	141	139	139	137	136	32
34	131	131	129	128	126	126	34
36	122	122	120	119	117	117	36
38	113	114	112	111	109	109	38
40	106	106	105	104	102	101	40
44		93.5	92.5	91.9	90.1	89.4	44
48			81.8	81.4	79.7	79.1	48
52			72.5	72.5	71	70.4	52
56				64.7	63.4	62.9	56
60					56.7	56.4	60
64					50.5	50.5	64
68						45.2	68

**Load Chart of LJ Configuration****Load chart -LJ 2/2**

Boom Length 48m, Boom Angle 85°, Jib Length 36~66m, Rear counterweight 250t, Carbody counterweight 90t

BL/R (m)	36	42	48	54	60	66	BL/R (m)
18	278						18
19	261						19
20	246	245					20
22	220	219	217				22
24	198	198	196	194			24
26	180	180	178	177	172	168	26
28	165	164	162	161	159	156	28
30	152	151	149	148	146	144	30
32	140	140	138	137	135	134	32
34	130	129	128	127	125	124	34
36	121	120	119	118	116	115	36
38	112	112	111	110	108	107	38
40	105	105	103	103	101	100	40
44		92.5	91.3	90.7	88.9	88.2	44
48			80.8	80.3	78.6	77.9	48
52			71.6	71.5	69.9	69.3	52
56				63.8	62.4	61.9	56
60					55.8	55.4	60
64					49.7	49.7	64
68						44.4	68

## Combination of LJDB Configuration

Combination of LJDB configuration						
Boom length (m)	Boom					
	H2	H6	H8A	H8B	H4	H9
42	1	1	1	-	1	1
48	1	2	1	-	1	1
54	1	1	2	-	1	1
60	1	2	2	-	1	1
66	1	1	3	-	1	1
72	1	2	3	-	1	1
78	1	1	3	1	1	1
84	1	2	3	1	1	1
90	1	1	3	2	1	1
96	1	2	3	2	1	1
102	1	1	3	3	1	1
108	1	2	3	3	1	1

Combination of LJDB configuration							
Boom length (m)	Jib						
	LJ2	H8D	LJ4	LJ6	LJ8A	LJ8B	LJ9
30	1	1	1	-	-	-	1
36	1	1	1	1	-	-	1
42	1	1	1	-	1	-	1
48	1	1	1	1	1	-	1
54	1	1	1	-	2	-	1
60	1	1	1	1	2	-	1
66	1	1	1	2	2	-	1
72	1	1	1	1	2	1	1
78	1	1	1	2	2	1	1
84	1	1	1	1	2	2	1
90	1	1	1	2	2	2	1
96	1	1	1	1	2	3	1
102	1	1	1	2	2	3	1
108	1	1	1	1	2	4	1
114	1	1	1	2	2	4	1

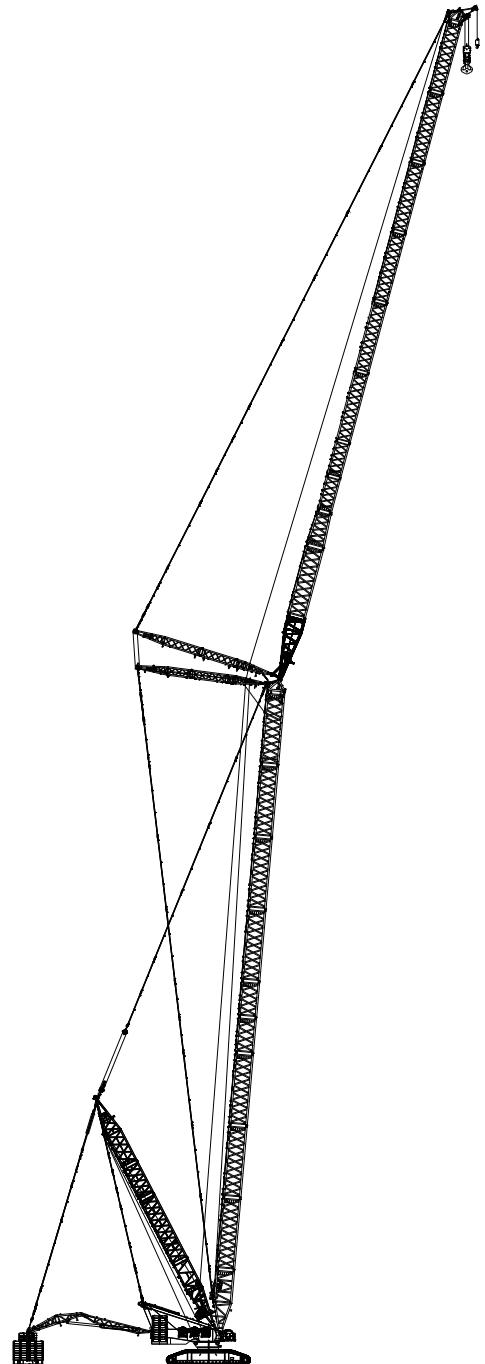

LJDB Configuration  
(48m~108m) + (30m~114m)

## Working Range of LJDB

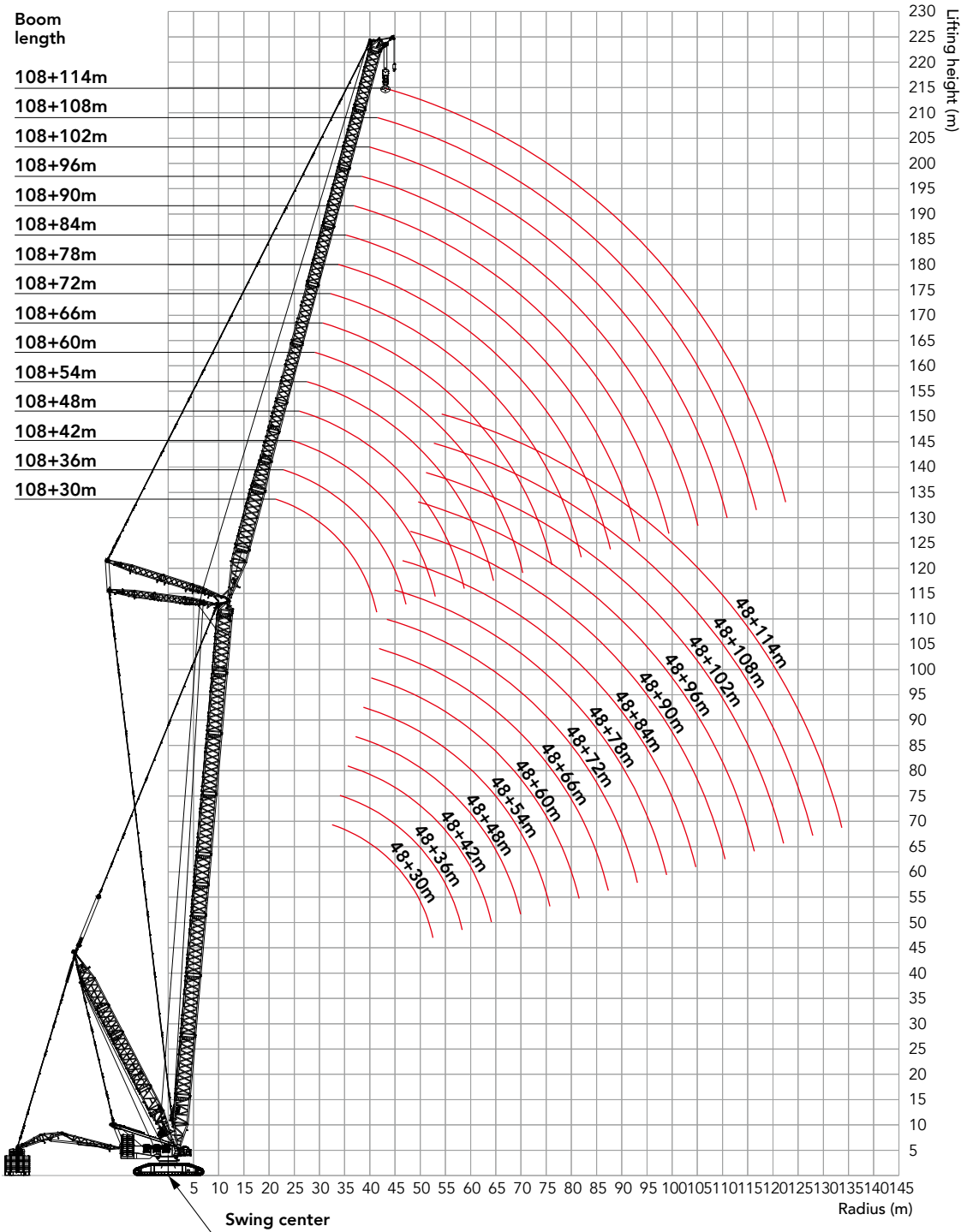



## Load Chart of LJDB Configuration

Note:

1. Meet the requirements of ISO4305.
2. The data with the asterisk mark (\*) in the table means that the superlift counterweight in this configuration is not off the ground.
3. The rated load in the table includes the weight of the hook, wire rope and other lifting tools. To obtain the weight can be lifted, use the rated load in the table to minus the weights of hooks, wire ropes and other lifting tools.

Load chart -LJDB 1/11																
Boom Length 48m, Boom Angle 85°, Jib Length 30~114m, Superlift Radius 30m, Superlift Counterweight 550t Rear Counterweight 250t, Carbody Counterweight 90t																
BL/R (m)	30	36	42	48	54	60	66	72	78	84	90	96	102	108	114	BL/R (m)
17	650*															17
18	650*	650*														18
19	650*	650*														19
20	650*	650*	650*													20
22	650*	650*	650*	568*												22
24	650*	650*	650*	566*	480*											24
26	599*	650*	638*	562*	478*	404*	345*									26
28	545*	604*	590*	551*	476*	403*	344*	292*								28
30	500*	552*	562*	524*	472*	401*	343*	291*	248*							30
32	467*	504*	510*	491*	460*	398*	341*	290*	246*	211*	181*					32
34	418*	457*	465*	470*	440*	395*	339*	288*	245*	210*	180*	157*				34
36	357*	416*	426*	437*	417*	387*	337*	287*	244*	209*	179*	156*	134*			36
38		376*	390*	403*	396*	370*	334*	285*	242*	207*	177*	155*	133*	114*		38
40		337*	359*	372*	375*	353*	331*	283*	240*	205*	176*	154*	131*	112*	96.2*	40
44			300*	320*	330*	321*	305*	278*	236*	202*	173*	152*	129*	110*	94.0*	44
48				274*	288*	289*	278*	262*	232*	199*	170*	149*	127*	108*	91.7*	48
52				229*	251*	259*	253*	242*	227*	195*	166*	147*	124*	106*	89.6*	52
56					216*	229*	228*	221*	212*	191*	163*	144*	121*	104*	87.3*	56
60						201*	205*	202*	195*	182*	160*	141*	119*	101*	85.0*	60
64						172*	181*	184*	179*	166*	149*	138*	116*	99.4*	82.8*	64
68							158*	167*	164*	152*	135*	136*	114*	97.2*	80.5*	68
72								148*	151*	140*	124*	133*	111*	94.9*	78.2*	72
76								127*	138*	129*	114*	128*	109*	93.0*	76.3*	76
80									123*	118*	104*	120*	106*	90.9*	74.1*	80
84										110*	96.1*	111*	104*	88.9*	72.0*	84
88										100*	88.0*	104*	100*	86.9*	70.0*	88
92											81.3*	97.0*	93.8*	85.0*	68.2*	92
96												89.8*	87.9*	83.1*	65.3*	96
100													82.1*	80.2*	59.3*	100
104													75.0*	75.1*	53.6*	104
108														70.1*	48.4*	108
112															43.3*	112
116															38.5*	116

## Load Chart of LJDB Configuration

Load chart -LJDB 2/11																
Boom Length 54m, Boom Angle 85°, Jib Length 30~114m, Superlift Radius 30m, Superlift Counterweight 550t Rear Counterweight 250t, Carbody Counterweight 90t																
BL/R (m)	30	36	42	48	54	60	66	72	78	84	90	96	102	108	114	BL/R (m)
17	650*															17
18	650*															18
19	650*	650*														19
20	650*	650*														20
22	650*	650*	613*	522*												22
24	650*	650*	607*	520*	445*											24
26	621*	630*	583*	517*	443*	378*										26
28	563*	586*	551*	509*	441*	376*	323*	277*								28
30	515*	545*	519*	484*	438*	375*	322*	276*	236*							30
32	478*	505*	486*	458*	427*	372*	321*	275*	235*	202*						32
34	436*	465*	453*	431*	406*	370*	319*	274*	234*	201*	172*					34
36	378*	427*	423*	405*	384*	360*	317*	273*	232*	200*	171*	150*	129*			36
38		389*	394*	381*	365*	345*	315*	271*	231*	198*	170*	149*	128*	109*		38
40		351*	366*	358*	346*	327*	307*	269*	230*	197*	169*	148*	127*	108*	92.8*	40
44			310*	314*	307*	296*	283*	263*	226*	194*	166*	146*	125*	107*	91.1*	44
48			249*	275*	272*	266*	258*	244*	222*	191*	164*	144*	122*	105*	89.1*	48
52				238*	240*	239*	233*	223*	212*	188*	161*	142*	120*	103*	87.0*	52
56					212*	213*	209*	204*	196*	184*	158*	139*	118*	101*	84.9*	56
60						189*	190*	186*	180*	171*	155*	137*	116*	98.9*	82.8*	60
64						168*	170*	168*	165*	159*	149*	134*	113*	96.8*	80.7*	64
68							153*	152*	151*	147*	137*	132*	111*	94.7*	78.6*	68
72								138*	138*	135*	125*	127*	108*	92.9*	76.7*	72
76								125*	126*	124*	115*	118*	106*	90.9*	74.7*	76
80									114*	114*	106*	110*	104*	88.9*	72.6*	80
84										104*	97.5*	102*	98.6*	87.0*	70.7*	84
88										96.3*	89.1*	94.3*	91.8*	85.1*	68.7*	88
92											81.9*	87.7*	85.5*	83.2*	67.0*	92
96												81.0*	79.4*	78.4*	65.2*	96
100												74.6*	73.9*	72.6*	61.1*	100
104													68.5*	67.7*	54.1*	104
108														63.0*	48.9*	108
112														58.3*	43.9*	112
116															40.4*	116

## Load Chart of LJDB Configuration

Load chart -LJDB 3/11																
Boom Length 60m, Boom Angle 85°, Jib Length 30~114m, Superlift Radius 30m, Superlift Counterweight 550t Rear Counterweight 250t, Carbody Counterweight 90t																
BL/R (m)	30	36	42	48	54	60	66	72	78	84	90	96	102	108	114	BL/R (m)
18	650*															18
19	650*															19
20	650*	646*														20
22	650*	638*	556*													22
24	650*	617*	551*	476*	411*											24
26	614*	577*	538*	473*	410*	351*										26
28	565*	539*	508*	468*	407*	350*	304*									28
30	520*	499*	475*	445*	404*	349*	302*	260*	223*							30
32	478*	463*	445*	423*	394*	347*	301*	260*	223*	192*						32
34	439*	431*	416*	399*	376*	344*	299*	259*	222*	191*	165*					34
36	397*	397*	389*	374*	356*	334*	298*	257*	221*	190*	164*	144*				36
38		367*	363*	353*	336*	319*	296*	256*	220*	189*	163*	143*	122*	105*		38
40		340*	338*	329*	319*	304*	286*	254*	218*	188*	162*	142*	122*	104*	89.5*	40
44			293*	289*	283*	273*	261*	246*	215*	186*	160*	140*	120*	103*	87.8*	44
48			253*	253*	251*	246*	238*	227*	212*	183*	158*	138*	118*	101*	86.1*	48
52				221*	223*	219*	215*	207*	198*	180*	155*	136*	116*	99.6*	84.2*	52
56					195*	195*	194*	188*	182*	173*	152*	134*	114*	97.8*	82.3*	56
60					172*	174*	175*	171*	167*	159*	149*	132*	112*	95.9*	80.4*	60
64						155*	155*	155*	152*	147*	141*	130*	110*	93.9*	78.5*	64
68							140*	140*	139*	135*	130*	125*	108*	92.2*	76.7*	68
72							126*	127*	127*	124*	120*	117*	105*	90.3*	74.8*	72
76								114*	115*	114*	111*	109*	103*	88.4*	72.8*	76
80									104*	104*	102*	101*	97.5*	86.6*	70.9*	80
84										95.4*	94.6*	93.3*	90.2*	84.7*	69.1*	84
88										86.8*	86.5*	86.3*	84.0*	81.6*	67.4*	88
92											79.7*	79.4*	78.0*	76.4*	65.6*	92
96												73.3*	72.3*	71.1*	63.9*	96
100													67.5*	66.6*	65.8*	100
104														61.6*	61.1*	104
108															56.6*	108
112															52.3*	112
116															39.7*	116

## Load Chart of LJDB Configuration

Load chart -LJDB 4/11																	
Boom Length 66m, Boom Angle 85°, Jib Length 30~114m, Superlift Radius 30m, Superlift Counterweight 550t Rear Counterweight 250t, Carbody Counterweight 90t																	
BL/R (m)	30	36	42	48	54	60	66	72	78	84	90	96	102	108	114	BL/R (m)	
18	650*															18	
19	650*															19	
20	650*	583*														20	
22	650*	575*	505*													22	
24	609*	565*	500*	436*												24	
26	564*	532*	493*	433*	377*	327*										26	
28	523*	498*	469*	428*	375*	326*	284*									28	
30	483*	464*	441*	413*	372*	325*	283*	245*								30	
32	445*	429*	414*	391*	367*	323*	282*	244*	210*	182*						32	
34	408*	400*	386*	368*	348*	320*	281*	243*	210*	181*	157*					34	
36	376*	369*	362*	348*	332*	312*	279*	242*	209*	181*	156*	137*				36	
38		342*	336*	326*	313*	296*	277*	241*	208*	180*	155*	136*	117*			38	
40		317*	313*	306*	296*	283*	267*	239*	207*	179*	155*	136*	116*	100*	85.7*	40	
44			272*	270*	264*	255*	244*	230*	204*	177*	153*	134*	115*	98.9*	84.3*	44	
48			235*	235*	234*	228*	222*	212*	200*	174*	151*	132*	113*	97.4*	82.7*	48	
52				206*	207*	204*	200*	192*	184*	172*	148*	131*	112*	95.8*	81.1*	52	
56					183*	182*	179*	175*	169*	161*	146*	129*	110*	94.1*	79.4*	56	
60					161*	161*	161*	159*	155*	149*	141*	127*	108*	92.6*	77.6*	60	
64						144*	145*	143*	141*	137*	132*	125*	106*	90.9*	76.1*	64	
68							129*	129*	129*	125*	122*	117*	104*	89.1*	74.3*	68	
72							116*	117*	117*	115*	112*	109*	102*	87.3*	72.5*	72	
76								106*	106*	105*	103*	101*	97.2*	85.6*	70.6*	76	
80									96.7*	96.5*	94.5*	93.3*	90.1*	83.8*	68.8*	80	
84									87.4*	88.0*	86.7*	85.9*	84.0*	81.7*	67.1*	84	
88										80.1*	79.7*	79.2*	77.6*	75.5*	65.5*	88	
92											72.7*	72.7*	71.4*	70.3*	63.8*	92	
96												66.8*	65.8*	65.0*	62.2*	96	
100													61.6*	61.0*	58.9*	100	
104														56.3*	54.3*	104	
108															51.6*	108	
112															47.5*	112	
116																41.0*	116

## Load Chart of LJDB Configuration

Load chart -LJDB 5/11																
Boom Length 72m, Boom Angle 85°, Jib Length 30~114m, Superlift Radius 30m, Superlift Counterweight 550t Rear Counterweight 250t, Carbody Counterweight 90t																
BL/R (m)	30	36	42	48	54	60	66	72	78	84	90	96	102	108	114	BL/R (m)
19	595*															19
20	595*															20
22	582*	517*	457*													22
24	560*	507*	452*	398*												24
26	519*	488*	446*	395*	348*											26
28	482*	457*	433*	390*	345*	302*	264*									28
30	446*	427*	408*	383*	342*	300*	263*	229*								30
32	412*	397*	382*	362*	338*	298*	262*	228*	198*							32
34	382*	371*	357*	341*	323*	295*	261*	227*	197*	172*						34
36	351*	343*	335*	322*	307*	289*	259*	226*	197*	171*	148*	130*				36
38	326*	319*	313*	304*	292*	276*	257*	225*	196*	170*	147*	130*	111*			38
40		296*	292*	285*	274*	263*	249*	223*	195*	170*	147*	129*	111*	95.8*		40
44		254*	254*	250*	244*	236*	227*	215*	192*	168*	145*	128*	110*	94.7*	80.5*	44
48			221*	219*	216*	212*	206*	197*	186*	165*	143*	126*	108*	93.4*	79.2*	48
52				191*	192*	189*	185*	179*	173*	162*	141*	125*	107*	92.1*	77.8*	52
56					170*	168*	166*	163*	157*	150*	139*	123*	105*	90.6*	76.5*	56
60					150*	151*	150*	147*	144*	138*	132*	121*	103*	89.0*	74.9*	60
64						133*	134*	133*	131*	127*	122*	117*	101*	87.4*	73.3*	64
68							120*	119*	119*	116*	113*	109*	99.8*	85.7*	71.6*	68
72							108*	108*	107*	106*	104*	101*	96.5*	84.1*	69.9*	72
76								97.7*	98.6*	97.5*	95.5*	93.8*	90.4*	82.4*	68.2*	76
80									89.3*	88.8*	87.2*	85.9*	83.4*	80.7*	66.7*	80
84									80.7*	80.5*	79.8*	79.4*	77.1*	75.4*	65.1*	84
88										73.5*	73.3*	73.1*	71.0*	69.6*	63.4*	88
92											66.8*	67.1*	65.6*	64.8*	61.8*	92
96											60.9*	61.1*	60.4*	59.4*	58.0*	96
100												56.2*	55.5*	55.0*	53.4*	100
104													51.0*	50.8*	49.6*	104
108														46.7*	45.9*	108
112														42.8*	42.1*	112
116															38.7*	116

## Load Chart of LJDB Configuration

Load chart -LJDB 6/11																
Boom Length 78m, Boom Angle 85°, Jib Length 30~114m, Superlift Radius 30m, Superlift Counterweight 550t Rear Counterweight 250t, Carbody Counterweight 90t																
BL/R (m)	30	36	42	48	54	60	66	72	78	84	90	96	102	108	114	BL/R (m)
20	529*															20
22	517*	462*														22
24	502*	453*	406*	359*												24
26	479*	443*	400*	356*	315*											26
28	446*	423*	392*	351*	313*	275*										28
30	414*	395*	376*	346*	310*	273*	241*	211*								30
32	383*	368*	353*	335*	306*	271*	240*	211*	184*							32
34	354*	342*	332*	315*	299*	269*	239*	210*	184*	160*						34
36	329*	319*	310*	298*	284*	265*	237*	209*	183*	159*	139*					36
38	304*	297*	290*	281*	270*	255*	235*	208*	182*	159*	138*	121*	105*			38
40		277*	271*	264*	255*	243*	231*	206*	181*	158*	138*	121*	104*	90.2*		40
44		239*	236*	232*	227*	219*	211*	199*	178*	156*	136*	120*	103*	89.3*	76.1*	44
48			207*	204*	202*	197*	191*	183*	174*	154*	134*	119*	102*	88.2*	75.0*	48
52				179*	179*	175*	172*	166*	160*	151*	132*	117*	101*	87.0*	73.8*	52
56				158*	158*	156*	155*	152*	147*	139*	130*	115*	99.7*	85.7*	72.5*	56
60					140*	140*	140*	137*	133*	129*	123*	114*	98.0*	84.3*	71.1*	60
64						124*	125*	123*	121*	118*	113*	109*	96.2*	82.8*	69.6*	64
68							112*	112*	110*	108*	104*	101*	94.4*	81.2*	68.1*	68
72							100*	101*	100*	98.8*	95.8*	93.8*	90.1*	79.9*	66.5*	72
76								90.4*	91.4*	89.7*	88.4*	86.7*	83.3*	78.3*	65.2*	76
80									82.4*	81.7*	80.6*	79.4*	76.7*	74.7*	63.6*	80
84									75.0*	74.5*	73.7*	73.3*	71.2*	69.0*	62.0*	84
88										67.6*	67.2*	67.3*	65.2*	64.4*	60.5*	88
92											61.3*	61.5*	60.1*	59.1*	57.4*	92
96											56.1*	55.9*	55.2*	54.7*	52.9*	96
100												51.5*	50.5*	50.3*	49.2*	100
104													46.8*	45.9*	44.9*	104
108													42.7*	42.1*	41.5*	108
112														38.7*	38.3*	112
116															35.2*	116

## Load Chart of LJDB Configuration

Load chart -LJDB 7/11																
Boom Length 84m, Boom Angle 85°, Jib Length 30~114m, Superlift Radius 30m, Superlift Counterweight 550t Rear Counterweight 250t, Carbody Counterweight 90t																
BL/R (m)	30	36	42	48	54	60	66	72	78	84	90	96	102	108	114	BL/R (m)
20	474*															20
22	464*	416*														22
24	451*	408*	367*													24
26	438*	399*	362*	323*	288*											26
28	413*	388*	355*	319*	286*	253*										28
30	383*	366*	347*	314*	282*	251*	223*									30
32	358*	343*	328*	308*	279*	249*	222*	195*	172*							32
34	331*	319*	309*	294*	275*	246*	221*	195*	171*	150*						34
36	308*	298*	290*	278*	264*	243*	219*	193*	170*	149*	130*					36
38	285*	278*	270*	262*	251*	239*	216*	192*	170*	149*	130*	114*				38
40		260*	253*	246*	237*	227*	214*	190*	168*	148*	129*	114*	98.8*	85.1*		40
44		225*	222*	217*	212*	205*	197*	186*	166*	146*	128*	113*	97.9*	84.3*	71.9*	44
48			194*	191*	189*	184*	179*	171*	163*	144*	126*	112*	96.8*	83.4*	71.0*	48
52				168*	167*	164*	161*	156*	150*	141*	124*	110*	95.5*	82.3*	69.9*	52
56				148*	148*	146*	145*	141*	136*	131*	122*	108*	94.0*	81.3*	68.7*	56
60					131*	131*	130*	127*	125*	120*	115*	107*	92.4*	79.9*	67.6*	60
64						116*	116*	115*	113*	109*	106*	102*	90.7*	78.5*	66.2*	64
68						104*	104*	104*	103*	100*	97.5*	94.8*	88.9*	77.1*	64.8*	68
72							93.8*	93.7*	93.4*	91.9*	89.3*	87.3*	83.8*	75.5*	63.4*	72
76								84.1*	84.6*	84.0*	81.7*	80.0*	77.5*	74.0*	61.9*	76
80									76.9*	76.4*	74.9*	73.9*	71.3*	69.3*	60.4*	80
84									69.5*	69.3*	68.4*	67.5*	65.6*	64.3*	59.0*	84
88										62.9*	62.1*	61.9*	60.2*	59.1*	56.7*	88
92											56.6*	56.4*	55.4*	54.6*	52.8*	92
96											51.9*	51.8*	50.7*	50.2*	48.4*	96
100												47.2*	46.6*	46.2*	44.9*	100
104													42.4*	42.4*	41.0*	104
108													38.7*	38.7*	37.7*	108
112														35.3*	34.6*	112
116															31.7*	116
120															29.0*	120

## Load Chart of LJDB Configuration

Load chart -LJDB 8/11																
Boom Length 90m, Boom Angle 85°, Jib Length 30~114m, Superlift Radius 30m, Superlift Counterweight 550t Rear Counterweight 250t, Carbody Counterweight 90t																
BL/R (m)	30	36	42	48	54	60	66	72	78	84	90	96	102	108	114	BL/R (m)
22	411*	370*														22
24	401*	363*	328*													24
26	389*	355*	323*	290*												26
28	377*	346*	316*	286*	258*	229*										28
30	355*	336*	309*	282*	255*	227*	203*									30
32	332*	318*	302*	276*	251*	225*	202*	178*								32
34	310*	298*	286*	270*	247*	222*	200*	177*	157*							34
36	287*	277*	269*	257*	243*	219*	198*	176*	157*	137*	120*					36
38	268*	259*	253*	243*	233*	216*	196*	175*	156*	137*	119*	106*				38
40		242*	237*	229*	221*	210*	193*	173*	155*	136*	119*	105*	91.4*			40
44		211*	208*	203*	198*	190*	183*	169*	152*	134*	118*	104*	90.6*	78.4*	66.8*	44
48			182*	179*	176*	171*	166*	159*	149*	132*	116*	103*	89.8*	77.6*	66.0*	48
52				158*	156*	153*	149*	144*	139*	129*	114*	102*	88.6*	76.6*	65.1*	52
56				139*	139*	136*	135*	131*	127*	121*	112*	100*	87.1*	75.5*	64.0*	56
60					123*	122*	121*	118*	116*	112*	106*	98.6*	85.6*	74.2*	62.8*	60
64						109*	109*	107*	105*	102*	98.5*	95.0*	83.9*	72.8*	61.6*	64
68						97.6*	98.1*	96.9*	95.9*	93.4*	90.3*	87.8*	82.2*	71.6*	60.4*	68
72							88.1*	87.5*	87.3*	85.7*	82.9*	80.7*	77.3*	70.1*	59.0*	72
76								78.7*	79.1*	77.7*	75.7*	74.5*	71.2*	68.6*	57.6*	76
80								71.2*	71.6*	70.6*	69.3*	68.3*	66.1*	64.1*	56.2*	80
84									65.0*	64.5*	63.4*	62.8*	60.6*	59.4*	54.8*	84
88										58.1*	57.6*	57.4*	55.8*	54.5*	52.5*	88
92										53.1*	52.5*	52.3*	51.3*	50.4*	48.4*	92
96											47.7*	47.4*	46.9*	46.0*	44.3*	96
100												43.7*	42.7*	42.3*	40.9*	100
104													39.1*	38.7*	37.7*	104
108													35.7*	35.3*	34.3*	108
112														32.1*	31.3*	112
116															28.6*	116
120															26.1*	120



## Load Chart of LJDB Configuration

Load chart -LJDB 9/11																	
Boom Length 96m, Boom Angle 85°, Jib Length 30~114m, Superlift Radius 30m, Superlift Counterweight 550t Rear Counterweight 250t, Carbody Counterweight 90t																	
BL/R (m)	30	36	42	48	54	60	66	72	78	84	90	96	102	108	114	BL/R (m)	
22	370*															22	
24	360*	328*	297*													24	
26	350*	320*	292*	263*												26	
28	339*	312*	286*	259*	234*											28	
30	328*	304*	280*	255*	231*	207*	186*									30	
32	311*	295*	273*	250*	228*	205*	185*	164*								32	
34	289*	278*	266*	244*	224*	202*	183*	163*	145*							34	
36	270*	261*	251*	239*	220*	199*	181*	162*	144*	127*						36	
38	252*	244*	237*	227*	215*	196*	179*	160*	143*	127*	111*	98.4*				38	
40	237*	228*	222*	214*	206*	193*	177*	159*	142*	126*	110*	98.0*	85.0*			40	
44		200*	195*	190*	185*	178*	170*	155*	139*	124*	109*	97.1*	84.3*	73.0*	62.2*	44	
48			172*	168*	165*	160*	155*	149*	136*	121*	107*	96.1*	83.3*	72.3*	61.5*	48	
52			151*	149*	147*	144*	141*	135*	130*	119*	105*	94.6*	82.0*	71.3*	60.6*	52	
56				132*	131*	128*	127*	123*	119*	114*	103*	92.8*	80.6*	70.2*	59.6*	56	
60					116*	115*	114*	111*	108*	104*	100*	90.9*	79.0*	68.9*	58.5*	60	
64						103*	102*	101*	99.1*	95.8*	92.3*	88.8*	77.5*	67.6*	57.3*	64	
68						92.4*	91.9*	90.7*	90.0*	87.6*	84.5*	81.9*	75.7*	66.1*	56.0*	68	
72							82.6*	82.0*	81.3*	79.7*	77.0*	75.6*	71.9*	64.6*	54.6*	72	
76								73.9*	73.7*	72.7*	70.7*	69.0*	66.5*	63.2*	53.4*	76	
80								67.0*	66.6*	65.8*	64.7*	63.7*	61.2*	59.3*	52.0*	80	
84									60.5*	60.0*	58.9*	58.1*	56.2*	54.8*	50.5*	84	
88										54.1*	53.5*	53.0*	51.4*	50.5*	48.3*	88	
92										49.6*	48.9*	48.6*	47.1*	46.3*	44.4*	92	
96											44.4*	44.1*	43.0*	42.4*	41.1*	96	
100												40.1*	39.4*	38.8*	37.4*	100	
104													36.6*	36.0*	35.4*	104	
108														32.5*	32.3*	108	
112															29.3*	112	
116																25.8*	116
120																23.4*	120

## Load Chart of LJDB Configuration

Load chart -LJDB 10/11																
Boom Length 102m, Boom Angle 85°, Jib Length 30~114m, Superlift Radius 30m, Superlift Counterweight 550t Rear Counterweight 250t, Carbody Counterweight 90t																
BL/R (m)	30	36	42	48	54	60	66	72	78	84	90	96	102	108	114	BL/R (m)
22	328*															22
24	320*	291*														24
26	311*	285*	260*	234*												26
28	302*	278*	255*	231*	210*											28
30	292*	270*	249*	227*	207*	186*										30
32	283*	262*	243*	223*	204*	184*	166*	148*								32
34	270*	254*	237*	218*	201*	181*	165*	147*	131*							34
36	252*	243*	230*	213*	197*	179*	163*	146*	131*	115*						36
38	236*	228*	221*	207*	193*	176*	161*	144*	130*	115*	101*					38
40	222*	213*	207*	199*	188*	172*	158*	143*	128*	114*	100*	89.2*	77.3*			40
44		187*	182*	178*	172*	165*	153*	139*	126*	112*	99.2*	88.3*	76.6*	66.5*	56.4*	44
48			162*	158*	155*	149*	144*	134*	122*	109*	97.3*	87.0*	75.6*	65.7*	55.8*	48
52			144*	140*	137*	134*	131*	126*	119*	106*	95.2*	85.4*	74.3*	64.8*	55.0*	52
56				125*	122*	120*	118*	115*	111*	104*	92.8*	83.7*	72.9*	63.7*	54.0*	56
60					110*	108*	107*	104*	101*	97.2*	90.3*	81.7*	71.3*	62.4*	52.9*	60
64					98.8*	97.3*	95.8*	94.2*	92.1*	89.2*	85.2*	79.6*	69.7*	61.0*	51.7*	64
68						86.7*	86.6*	85.0*	83.6*	81.5*	78.1*	76.2*	67.9*	59.5*	50.5*	68
72							78.2*	77.0*	76.4*	74.1*	71.9*	69.8*	66.0*	58.1*	49.2*	72
76								69.5*	69.3*	67.2*	65.6*	64.0*	61.6*	56.6*	47.9*	76
80								62.9*	62.7*	61.0*	59.5*	58.6*	56.3*	54.7*	46.5*	80
84									56.6*	55.9*	54.2*	53.7*	52.0*	50.7*	45.0*	84
88										50.9*	49.6*	49.0*	47.4*	46.4*	43.7*	88
92										45.9*	45.3*	44.6*	43.4*	42.7*	40.7*	92
96											40.9*	40.7*	39.5*	38.7*	37.5*	96
100												37.1*	36.2*	35.4*	34.1*	100
104												33.8*	32.8*	32.3*	31.2*	104
108													29.9*	29.3*	28.5*	108
112														26.9*	26.0*	112
116														24.4*	23.2*	116
120															21.1*	120

## Load Chart of LJDB Configuration

Load chart -LJDB 11/11																
Boom Length 108m, Boom Angle 85°, Jib Length 30~114m, Superlift Radius 30m, Superlift Counterweight 550t Rear Counterweight 250t, Carbody Counterweight 90t																
BL/R (m)	30	36	42	48	54	60	66	72	78	84	90	96	102	108	114	BL/R (m)
22	294*															22
24	288*	262*														24
26	280*	257*	235*													26
28	272*	250*	230*	209*	190*											28
30	263*	243*	225*	205*	187*	169*										30
32	255*	236*	219*	201*	184*	167*	151*									32
34	246*	229*	214*	197*	181*	164*	150*	134*								34
36	238*	222*	208*	192*	177*	162*	148*	132*	119*	105*						36
38	223*	214*	202*	187*	174*	159*	145*	131*	118*	104*	92.2*					38
40	209*	201*	195*	182*	170*	156*	143*	129*	117*	104*	91.7*	81.4*				40
44		177*	173*	166*	161*	149*	138*	125*	114*	102*	90.2*	80.4*	69.7*	60.5*	51.2*	44
48			153*	149*	145*	140*	133*	121*	111*	99.5*	88.4*	79.1*	68.7*	59.8*	50.6*	48
52			135*	133*	130*	126*	122*	116*	107*	96.7*	86.2*	77.4*	67.4*	58.8*	49.8*	52
56				118*	116*	113*	110*	107*	103*	93.7*	83.8*	75.5*	65.9*	57.7*	48.8*	56
60					103*	101*	100*	97.9*	95.1*	90.5*	81.2*	73.7*	64.3*	56.4*	47.7*	60
64					93.3*	91.5*	90.4*	88.2*	86.2*	83.2*	78.5*	71.5*	62.6*	55.0*	46.5*	64
68						82.2*	81.8*	80.1*	78.8*	76.0*	72.9*	69.2*	60.8*	53.4*	45.4*	68
72							73.6*	72.1*	71.2*	69.1*	66.8*	65.1*	58.8*	52.0*	44.0*	72
76							66.6*	65.2*	64.4*	63.0*	60.9*	59.6*	56.8*	50.3*	42.6*	76
80								59.4*	58.7*	57.3*	55.6*	54.5*	52.1*	48.7*	41.2*	80
84									53.5*	52.0*	50.6*	49.9*	48.1*	46.9*	39.8*	84
88										47.4*	46.0*	45.5*	44.0*	42.7*	38.3*	88
92										43.2*	42.2*	41.3*	40.2*	39.2*	36.9*	92
96											38.1*	37.8*	36.6*	35.9*	34.1*	96
100												34.4*	33.2*	32.8*	31.3*	100
104												31.0*	30.0*	29.8*	28.6*	104
108													27.6*	27.0*	25.7*	108
112														24.4*	23.3*	112
116														22.1*	21.1*	116
120															19.0*	120

## Combination of HJFJDB Configuration

Combination of HJFJDB configuration												
Boom length (m)	Boom						Jib					
	H2	H3	H6	H8A	H8B	H4	H8D	LJ4	LJ6	LJ8A	LJ8B	LJ9
102	1	-	2	3	2	1	-	1	-	-	-	1
108	1	-	1	3	3	1	-	1	-	-	-	1
114	1	-	2	3	3	1	-	1	-	-	-	1
120	1	-	1	3	3	1	1	1	-	-	-	1
126	1	-	2	3	3	1	1	1	-	-	-	1
132	1	-	2	3	3	1	1	1	1	-	-	1
138	1	-	2	3	3	1	1	1	-	1	-	1
144	1	-	2	3	3	1	1	1	1	1	-	1
150	1	-	2	3	3	1	1	1	2	1	-	1
156	1	-	2	3	3	1	1	1	1	2	-	1
162	1	-	2	3	3	1	1	1	2	2	-	1
165	1	1	2	3	3	1	1	1	2	2	-	1
168	1	-	2	3	3	1	1	1	1	2	1	1
171	1	1	2	3	3	1	1	1	1	2	1	1

Note: For boom length of 138m~171m, the mid-point suspension cable must be used, otherwise, the boom system may break.

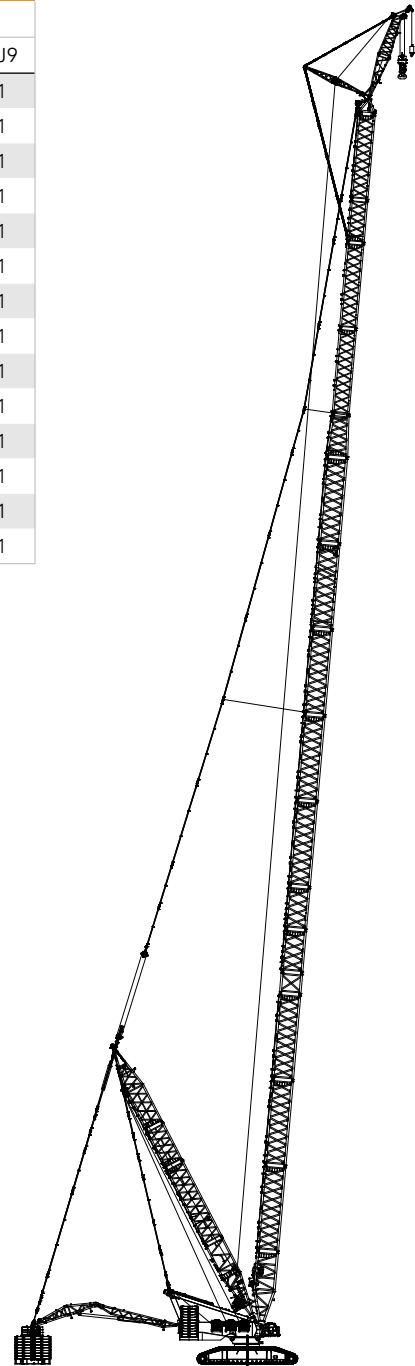

HJFJDB Configuration  
(102m~171m) +12m

# Working Range of HJFJDB

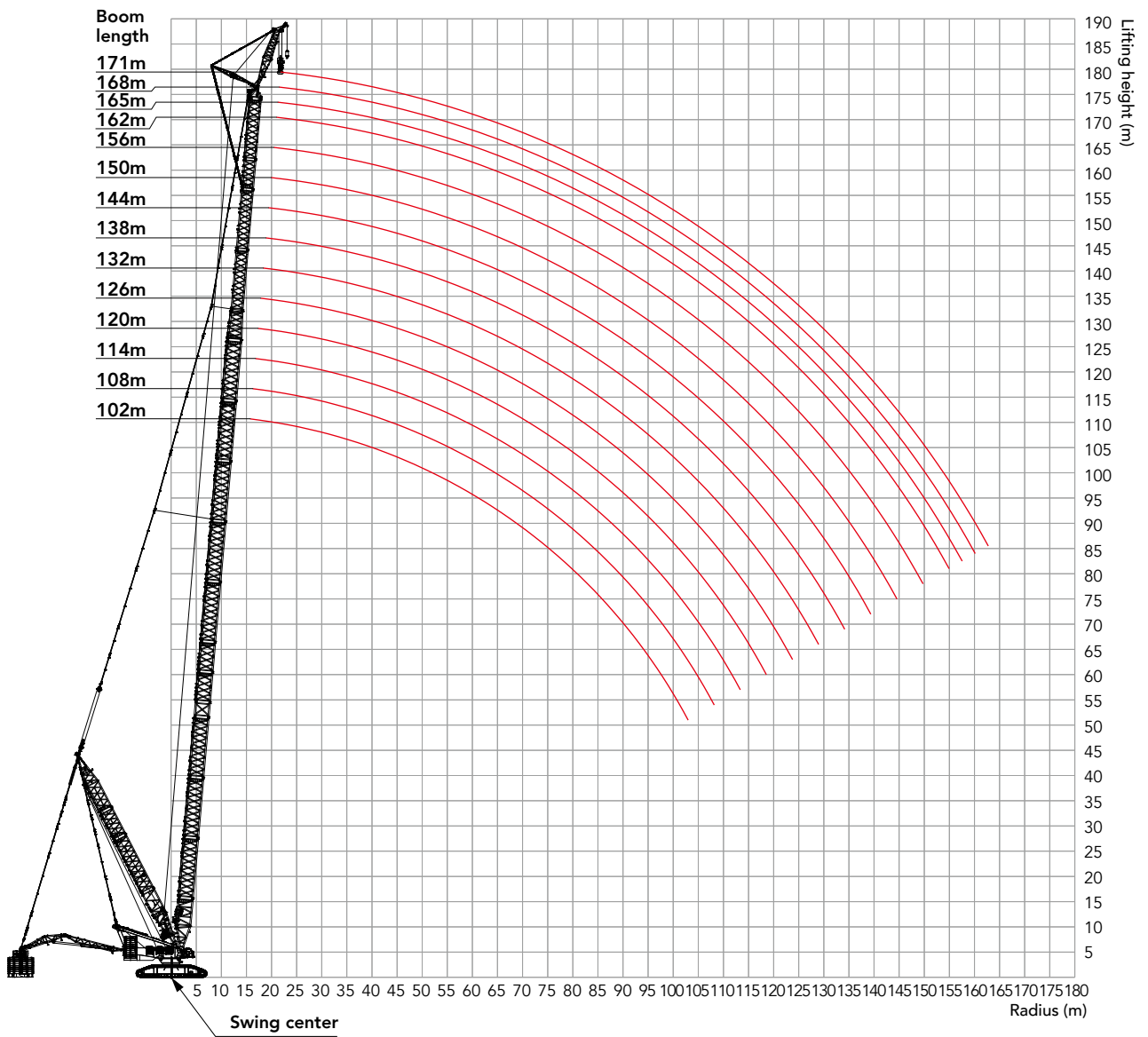

## Load Chart of HJFJDB Configuration

Note:

1. Meet the requirements of ISO4305.
2. The data with the asterisk mark (\*) in the table means that the superlift counterweight in this configuration is not off the ground.
3. The rated load in the table includes the weight of the hook, wire rope and other lifting tools. To obtain the weight can be lifted, use the rated load in the table to minus the weights of hooks, wire ropes and other lifting tools.

### Load chart -HJFJDB\_15

Boom Length 102~171m, Jib Length 12m, Boom to Jib Angle 15°, Superlift Radius 30m, Superlift Counterweight 550t  
Rear Counterweight 250t, Carbody Counterweight 90t

BL/R(m)	102	108	114	120	126	132	138	144	150	156	162	165	168	171	BL/R(m)
17	244*	242*													17
18	243*	241*	240*	235*											18
19	244*	241*	239*	235*	231*	226*									19
20	244*	241*	238*	235*	231*	226*	222*	215*							20
22	244*	241*	238*	235*	231*	226*	222*	215*	197*	178*	157*	151*	139*		22
24	245*	241*	238*	236*	231*	226*	222*	216*	198*	177*	156*	150*	138*	133*	24
26	245*	241*	238*	235*	231*	228*	223*	217*	197*	177*	155*	149*	137*	132*	26
28	242*	241*	240*	235*	231*	227*	222*	216*	198*	176*	154*	148*	136*	131*	28
30	239*	239*	238*	235*	232*	227*	223*	217*	198*	175*	153*	147*	135*	130*	30
32	236*	236*	233*	232*	232*	228*	224*	216*	196*	174*	152*	147*	134*	129*	32
34	233*	233*	231*	230*	231*	229*	223*	217*	196*	173*	151*	146*	133*	128*	34
36	230*	230*	228*	227*	229*	228*	224*	217*	196*	172*	150*	145*	132*	127*	36
38	226*	227*	225*	225*	226*	226*	224*	216*	195*	171*	149*	144*	131*	126*	38
40	224*	224*	225*	222*	224*	223*	223*	211*	194*	170*	148*	143*	130*	125*	40
44	219*	219*	219*	219*	221*	221*	221*	204*	191*	168*	146*	141*	128*	123*	44
48	214*	214*	214*	213*	217*	218*	217*	196*	184*	166*	144*	139*	126*	121*	48
52	205*	208*	210*	210*	215*	215*	214*	189*	178*	160*	142*	137*	124*	119*	52
56	196*	201*	204*	206*	209*	211*	213*	182*	171*	155*	140*	135*	121*	117*	56
60	189*	192*	196*	200*	202*	209*	210*	176*	166*	149*	134*	132*	119*	115*	60
64	182*	186*	190*	193*	195*	206*	207*	172*	160*	144*	130*	130*	117*	113*	64
68	176*	180*	184*	187*	189*	201*	207	166*	155*	140*	126*	128*	113*	111*	68
72	170*	173*	177*	181*	184*	195	201	161*	151*	136*	121*	126*	109*	109*	72
76	165*	169*	171*	176*	178	188	190	157*	146*	132*	118*	122*	106*	106*	76
80	159*	164*	167	170	173	176	176	154*	142*	128*	115*	119*	103*	104*	80
84	156*	159	163	166	165	164	164	150	139*	125*	111*	116*	100*	102*	84
88	151	155	157	157	154	153	153	147	136	122*	109*	112*	97.5*	100*	88
92	146	150	147	147	144	142	142	141	133	119*	106*	110*	94.9*	98.9*	92
96	143	140	137	137	134	133	133	132	130	117	104*	108*	92.4*	96.5*	96
100	134	132	129	129	126	124	124	123	121	114	101*	105	90.5*	94.1*	100
104		124	121	121	118	116	116	115	113	112	99.8	103	88.7*	92.2*	104
108		116	113	113	110	109	109	107	106	106	98.5	102	86.9*	90.4	108
112			106	106	103	102	102	101	99.6	99.3	96.7	96	85.4	89.1	112
116				100	97.2	96	96	94.6	93.2	92.9	91.3	89.6	84.2	87.8	116
120					91.1	90	90	88.6	87.2	86.9	85.3	83.6	83	83.8	120
124						84.3	84.4	83	81.6	81.3	79.7	78	79.9	78.2	124
128						79	79	77.7	76.3	76	74.4	72.8	74.6	73	128
132							74	72.7	71.3	71.1	69.5	67.8	69.7	68	132
136								68	66.6	66.4	64.8	63.2	65	63.4	136
140									62.2	61.9	60.4	58.8	60.6	59	140
144									58	57.8	56.2	54.6	56.4	54.8	144
148										53.8	52.3	50.6	52.5	50.8	148
152											48.5	46.8	48.7	47.1	152
156												43.3	45.1	43.5	156
160													41.7	40.1	160



## Zhejiang Sany Equipment Co.,LTD

SANY Crawler Crane Industrial Park, No. 2188 Daishan Road, Wuxing District, Huzhou City,  
Zhejiang Province, P. R. China Zip 313028  
Consulting [sanycrane@sanygroup.com](mailto:sanycrane@sanygroup.com) (Crane BU) / [crd@sany.com.cn](mailto:crd@sany.com.cn) (IHQ)  
After-sales Service 0086-400 6098 318

**Reminder:**

Any change in the technical parameters and configuration due to product modification or upgrade may occur without prior notice.  
The machine in the picture may include additional equipment. This brochure is for reference only, and goods in kind shall prevail.  
Copyright at SANY. No part of this brochure may be copied or used for any purpose without written approval from SANY.

© Edited in February 2024

